



CAT 4200-M-2

Parflex Division - Multitube®

Instrument and Heat Trace Tubing Products



ENGINEERING YOUR SUCCESS.

Extra care is taken in the preparation of this literature but Parker is not responsible for any inadvertent typographical errors or omissions. Information subject to change without notice. The information in this catalog is only accurate as of the date of publication. For a more current information base, please consult the Parflex Division web site at www.parker.com/pfd.



FAILURE OR IMPROPER SELECTION OR IMPROPER USE OF THE PRODUCTS AND/OR SYSTEMS
DESCRIBED HEREIN OR RELATED ITEMS CAN CAUSE DEATH, PERSONAL INJURY AND PROPERTY DAMAGE.

This document and other information from Parker Hannifin Corporation, its subsidiaries and authorized distributors provide product and/or system options for further investigation by users having technical expertise. It is important that you analyze all aspects of your application and review the information concerning the product or system in the current product catalog. Due to the variety of operating conditions and applications for these products or systems, the user, through its own analysis and testing, is solely responsible for making the final selection of the products and systems and assuring that all performance, safety and warning requirements of the application are met.

The products described herein, including without limitation, product features, specifications, designs, availability and pricing, are subject to change by Parker Hannifin Corporation and its subsidiaries at any time without notice.

Offer of Sale

The items described in this document are hereby offered for sale by Parker Hannifin Corporation, its subsidiaries or its authorized distributors. This offer and its acceptance are governed by the provisions stated in the "Offer of Sale".

Welcome to The Parflex Division



Our Charter

To be the global leader in engineered polymer-based products while providing system solutions for the conveyance and control of fluids

As part of the Fluid Connectors Group, the Parflex Division is responsible for the design and manufacture of hoses and tubing to handle extreme applications. Products include thermoplastic and fluoropolymer hose and tubing, hose bundles, instrumentation tubing, harnesses and accessories.

The Parflex Division includes the Ravenna division headquarters in Ohio, and manufacturing facilities in:

- Manitowoc, WI
- Fort Worth, TX
- Stafford, TX
- Randleman, NC
- Monterrey, Mexico

Section 1 — Chemical Processing & Refineries..... 1

- Temptube®—Single Tube Insulated..... 1
- Steam Trace—LT Series Light Trace..... 5
- Steam Trace—HT Series Heavy Trace..... 9
- Electric Trace—Self-Regulating..... 16

Section 2 — Power Generation..... 34

- Intermittent High Temperature Steam Purge- Freeze Protection..... 34
- Continuous High Temperature Steam Purge- Freeze Protection 37

Section 3 — Process Control and Environmental Monitoring Systems.. 40

- Analyzer Bundles..... 56
- Probe Support..... 56
- Constant Watt - Low Temperature Maintenance..... 40
- Constant Watt - High Temperature Maintenance..... 45
- Mineral Insulated - High Temperature Maintenance..... 50

Section 4 — Industrial Plant - Robotics - Laboratory 58

- Metal & Plastic tube Bundles..... 58
 - Metal Tubing Bundles..... 59
 - Plastic Tubing Bundles..... 62











Section 5 — General Technical Data..... 64





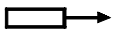



- Plastic Tubing Pressure and Chemical Compatibility Chart..... 64
- Metal Tubing Pressure and Chemical Compatibility Chart..... 67
- Jacket Material Selection Chart 70
- Seamless Tubing Length Chart and Physical Data 71
- Safety Guide 75



DISCONTINUED

Accessories	
- RTV End Sealant..... 13	- Heat Shrink Boots..... 32
- Enclosure Feed Through..... 32	- End Seal Boot..... 14
- Splice Kits..... 14	- Self-Regulating Power Kit..... 29
- Temperature Controllers..... 31	- Constant Watt Power Kit..... 53

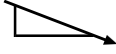
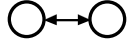
SYMBOL	DEFINITION
	Armor O.D
	Heat Loss
	Heat Gain
	Horizontal/Vertical Support Centers
	Insulation Thickness
	Jacket Thickness
	Maximum Circuit Length
	Maximum Pulling Tension
	Minimum Bend Radius
	Mounting Thread Size
	Nominal Product O.D.

SYMBOL	DEFINITION
	Nominal Throat Diameter
	Number of Tubes
	R-Factor
	Part Number
	Process Tube O.D.
	Product Weight
	Shipping Weight
	Slope
	Spacing
	Tracer Tube O.D.

Section 1

Temptube® Preinsulated Tubing

**Introduction:**

Parflex Temptube® Preinsulated tubing is thermally insulated with a non-hygroscopic inorganic fiberglass material and protected with a flexible, black, flame-resistant PVC jacket.

Performance Data:

Parflex standard Temptube® is thermally insulated for transfer of fluids or gases up to 400°F (204°C) while maintaining an outer jacket surface temperature of 140°F (60°C), meeting NEC Personnel Protection Code 427.12.

Insulated bundles rated up to 1200°F (649°C) are available upon request. Contact Parker Hannifin for more details.

Tubing is available in many alloys and sizes, including metric size. See “How to Order” on page 3 for specifying part numbers to meet your application.

General:

Parflex Temptube® is designed to provide an economical and highly efficient method of conveying steam or other hot materials through a plant and is intended to replace hard piping and field-installed insulation.

Applications:

The Temptube® products are typically used in steam supply lines, condensate return lines, cooling water lines, lubrication lines, refrigeration lines, and liquid nitrogen lines.

Tubing:

Type 122 DHP Seamless Copper and 316/316L Welded and Seamless Stainless Steel are standard. Additional materials and wall thicknesses are available upon request. For material specification of metal tubing, see technical data section of the catalog. Consult Division for details.

Insulation:

Air-spaced, cross wrapped applied non-hygroscopic fiberglass thermal insulation provides minimum heat loss. Optional insulation thicknesses are available; such as, 0.36”, 0.72” and 0.96” insulation used in Cryogenic, Liquid CO₂ and Liquid Nitrogen applications, see Performance Chart for heat gain rates. For other thicknesses, consult factory.

Jacket:

The tough, black, 105°C-rated, flame-resistant PVC (FR-PVC) jacket protects the tubing against corrosive atmospheres, water, oils, acids, alkalies and most chemicals. Additional jacket materials are available upon request. For jacket material specifications, see the Technical Data section of the catalog. Consult Division for additional details.

Testing:

Each tube in every length of Parflex Temptube® is pressure tested prior to shipment to assure the instrument engineer a high-quality, reliable, trouble-free product. For Testing Specifications, see Technical Data Section of the catalog.

Accessories:

Accessories are available for connecting multiple lengths of Temptube® bundles and sealing bundle ends.

NOTE: It is absolutely necessary to seal the ends against contamination from moisture and/or corrosive liquids. Parker Hannifin cannot assume any liability for product damage caused by moisture from unsealed ends.

**WARNING**

This product can expose you to chemicals including Antimony Oxide (Antimony Trioxide), which is known to the State of California to cause cancer. For more information go to www.P65Warnings.ca.gov.

How To Specify & Order

TT – Temptube[®], Single Tube Preinsulated Bundle

Maximum Internal Exposure up to 400°F (204°C)

TT - 2 08 35 - V B

TT Bundle Type	2 Process Tube Material	08 Process Tube Size	35 Process Tube Size
TT= Temptube Single Tube Insulated and Jacketed	1= Smls Copper Type DHP Alloy No 122. ASTM B68/B75 2= Welded Stainless Steel Type 316/316L ASTM A269 3= Welded Stainless Steel Type 304 ASTM A269 B= Smls 316/316L ASTM A269 C= Smls 304 ASTM A269 D= Smls Monel Type 400 E= Smls Hastelloy C22 H= Smls 316H ASTM A213 I = Smls Incoloy 825 L= Electropolish Smls 316/316L ASTM A 269 (10Ra Max) M= Smls 316/316L ASTM A213 S= Silco Smls 316/316L ASTM A269 P= PFA Fluoropolymer F= FEP Fluoropolymer T= TFE Fluoropolymer 7= Parflex 919 PTFE SS Braided Hose 9= Customer Specified Tube Material	O.D. See Selection Charts Imperial 02=1/8" 03=3/16" 04=1/4" 05=5/16" 06=3/8" 07=7/16" 08=1/2" 10=5/8" 12=3/4" 16=1" Metric MA=2mm MB=4mm MC=6mm MD=8mm ME=10mm MF=12mm MG=14mm MH=16mm	Wall Thickness See Selection Charts Imperial 16=.016" 20=.020" 28=.028" 30=.030 31=.031" 32=.032" 35=.035" 40=.040" 47=.047" 49=.049" 50=.050" 62=.062" 65=.065" 83=.083" Metric 89=.89mm 10=1.0mm 15=1.5mm 20=2.0mm 25=2.5mm

V Jacket Material	B Jacket Color
V=FR-PVC T=FR-TPE U=FR-PUR P=PUR R=TPR E=FRPE L=LDPE F=PVDF	N=Black, B=Blue G=Green O=Orange Y=Yellow P=Purple R=Red W=White
Note: Parflex standard jacket material is FR-PVC	Note: Parflex standard color jacket is black

Note: For standard black FR-PVC jacketed products the -VN may be dropped.



WARNING

This product can expose you to chemicals including Antimony Oxide (Antimony Trioxide), which is known to the State of California to cause cancer. For more information go to www.P65Warnings.ca.gov.

Physical Data*

#	Tubing			Insulation Thickness (in.)***	Jacket Thickness (in.)	Nominal Product O.D. (in.)	Minimum Bending Radius (in.)	Maximum Pulling Tension (lbs.)	Product Weight (lbs/100ft)	Horizontal/ Vertical Support Centers (ft.)
	Size (in.)									
	Material	O.D.	Wall							
TT-10430	Copper	1/4	0.030	0.20	.08	.81	8	150	21.6	5
TT-10632	Copper	3/8	0.032	0.24	.08	1.01	10	250	31.7	6
TT-10835	Copper	1/2	0.035	0.24	.08	1.14	12	350	40.8	8
TT-10649	Copper	3/8	0.049	0.24	.08	1.01	10	250	37.8	6
TT-10849	Copper	1/2	0.049	0.24	.08	1.14	12	350	47.9	8
TT-20435	Welded Stainless Steel	1/4	0.035	0.20	.08	.81	8	250	21.7	6
TT-20635	Welded Stainless Steel	3/8	0.035	0.24	.08	1.01	10	400	31.1	7
TT-20835	Welded Stainless Steel	1/2	0.035	0.24	.08	1.14	12	550	38.5	8
TT-20849	Welded Stainless Steel	1/2	0.049	0.24	.08	1.14	12	550	44.8	8
TT-B0435	Seamless Stainless Steel	1/4	0.035	0.20	.08	.81	8	250	21.7	6
TT-B0635	Seamless Stainless Steel	3/8	0.035	0.24	.08	1.01	10	400	31.1	7
TT-B0835	Seamless Stainless Steel	1/2	0.035	0.24	.08	1.14	12	550	38.5	8
TT-B0849	Seamless Stainless Steel	1/2	0.049	0.24	.08	1.14	12	550	44.8	8

*All values are nominal. Dimensional data to be used as reference only.

**Available with .049" wall copper tubing.

***Optional insulation thicknesses are available. For other thicknesses, consult factory.

Performance Characteristics

Steam Pressure and Temperature		50 PSIG @ 298°F		80 PSIG @ 329°F		100 PSIG @ 338°F		120 PSIG @ 350°F		150 PSIG @ 366°F		230 PSIG @ 400°F		
Ambient Temperature		80°F		80°F		80°F		80°F		80°F		80°F		
Tube O.D. (in.)	Nominal Product O.D. (in.)	Insul. Thick (in.)	Heat Loss*	Jacket temp**	Heat Loss*	Jacket temp**	Heat Loss*	Jacket temp**	Heat Loss*	Jacket temp**	Heat Loss*	Jacket temp**	Heat Loss*	Jacket temp**
1/4	.81	.20	28.5	120	31.9	125	33.7	128	35.3	130	37.4	133	41.8	139
3/8	1.015	.24	33.6	118	37.6	122	39.8	125	41.6	127	44.1	130	49.3	136
1/2	1.14	.24	40.4	121	45.3	125	47.8	128	50.1	130	53.0	133	59.3	140

*Heat loss is measured in Btu/Hr., per linear foot of tubing

**Jacket temperature measured at the surface in °F.

NOTE: The performance figures presented above have been calculated to be used as a guide only. Actual performance may vary with individual plant conditions.



WARNING

This product can expose you to chemicals including Antimony Oxide (Antimony Trioxide), which is known to the State of California to cause cancer. For more information go to www.P65Warnings.ca.gov.

Performance Characteristics

Part Number #	Tubing		Insulation Thickness (in.)*	Jacket Thickness (in.)	Nominal Product O.D. (in.)	Heat Gain/Loss Rates & R-factors at 70° F ambient					
	Size (in.)					Process, LN2 = -320°F		Process, Liquid CO2 = -70°F		Process, Steam = 400°F	
	O.D.	Wall				Heat Gain Rate, (BTU/hr) ft	R=factor, °F/ (BTU/hr) ft	Heat Gain Rate, (BTU/hr) ft	R=factor, °F/ (BTU/hr) ft	Heat Loss Rate, (BTU/hr) ft	R=factor, °F/ (BTU/hr) ft
TT-10430-VN-I	1/4	.030	.36	.08	1.13	18.3	21.3	10.7	13.0	30.9	10.7
TT-10632-VN-I	3/8	.032	.36	.08	1.26	23.0	17.0	13.4	10.4	38.5	8.6
TT-10835-VN-I	1/2	.035	.36	.08	1.38	27.5	14.2	16.0	8.8	45.7	7.2
TT-20435-VN-I	1/4	.035	.36	.08	1.13	18.3	21.3	10.7	13.0	30.9	10.7
TT-20635-VN-I	3/8	.035	.36	.08	1.26	23.0	17.0	13.4	10.4	38.5	8.6
TT-20835-VN-I	1/2	.035	.36	.08	1.38	27.5	14.2	16.0	8.8	45.7	7.2
TT-10430-VN-R	1/4	.030	.72	.08	1.85	13.5	29.0	8.1	17.3	23.5	14.0
TT-10632-VN-R	3/8	.032	.72	.08	1.98	16.3	24.0	9.7	14.4	28.3	11.7
TT-10835-VN-R	1/2	.035	.72	.08	2.10	18.9	20.7	11.3	12.4	32.8	10.1
TT-20435-VN-R	1/4	.035	.72	.08	1.85	13.5	29.0	8.1	17.3	23.5	14.0
TT-20635-VN-R	3/8	.035	.72	.08	1.98	16.3	24.0	9.7	14.4	28.3	11.7
TT-20835-VN-R	1/2	.035	.72	.08	2.10	18.9	20.7	11.3	12.4	32.8	10.1
TT-10430-VN-X	1/4	.030	.96	.08	2.33	12.0	32.5	7.2	19.3	21.2	15.6
TT-10632-VN-X	3/8	.032	.96	.08	2.46	14.3	27.3	8.6	16.3	25.1	13.1
TT-10835-VN-X	1/2	.035	.96	.08	2.58	16.4	23.8	9.9	14.2	28.8	11.5
TT-20435-VN-X	1/4	.035	.96	.08	2.33	12.0	32.5	7.2	19.3	21.2	15.6
TT-20635-VN-X	3/8	.035	.96	.08	2.46	14.3	27.3	8.6	16.3	25.1	13.1
TT-20835-VN-X	1/2	.035	.96	.08	2.85	16.4	23.8	9.9	14.2	28.8	11.5

*Optional insulation thicknesses are available. For other thicknesses, consult factory.

NOTE: The performance figures presented above have been calculated to be used as a guide only. Actual performance may vary with individual plant conditions.



WARNING

This product can expose you to chemicals including Antimony Oxide (Antimony Trioxide), which is known to the State of California to cause cancer. For more information go to www.P65Warnings.ca.gov.

LT – Light Steam Trace

Maximum Internal Exposure Temperature Rating up to 400°F (204°F)



General

Parker LT Temptrace® Light Steam Trace Tubing consists of single or multiple process tubes insulated from a single tracer with non-hygroscopic glass fiber insulation and overall non-hygroscopic glass fiber insulation and black, 105°C rated, flame-resistant PVC (FR PVC) jacket.

The LT Series Temptrace® is designed to utilize saturated steam pressures to 230 PSIG (15.8 BAR) and 400°F (204.4°C) without generating a process tube temperature in excess of 200°F (93°C) or a jacket surface temperature greater than 140°F (60°C) at 80°F (26.6°C) ambient. Standard product has a Maximum Temperature Rating (MTR*) of 400°F (204.4°C). Higher temperature rated designs are available. Consult Division for details.

*Maximum Temperature Rating is the maximum allowable temperature of the tracing fluid. Temperatures in excess of this may damage the product or alter its performance.

Applications

The LT Temptrace® permits use of higher pressure steam to heat trace instrument lines carrying water, light oil, paraffin, paraffin-based fluids and temperature-sensitive chemicals. Parker LT Temptrace® is ideal for simple instrument line freeze protection and viscosity maintenance applications.

Tubing

Type 122 DHP Seamless Copper and 316/316L Welded Stainless Steel are standard. Additional materials, wall thicknesses and seamless stainless steel are available upon request. For Material Specifications of metal tubing, see *Technical Data* section of the catalog. Consult Division for details.

Insulation

Air-spaced, cross wrapped applied non-hygroscopic fiberglass thermal insulation for minimum heat loss. The insulated tracer provides a more constant process tube temperature over long tubing runs.

Jacket

The tough, black, 105°C rated, flame-resistant PVC (FR PVC) jacket protects the tubing against corrosive atmospheres, water, oils, acids, alkalies and most chemicals. Additional jacket materials are available upon request. For Material Specifications of jackets, see *Technical Data* section of the catalog. Consult Division for additional details.

Testing

Each tube in every length of Parker Temptrace® is pressure tested prior to shipment to assure the instrument engineer a high quality, reliable, trouble-free product. For Testing Specifications, see *Technical Data* section of the catalog.

Accessories

Accessories are available for connecting multiple lengths of steam trace bundles and sealing bundle ends.

NOTE: It is absolutely necessary to seal the ends against contamination from moisture and/or corrosive liquids. Parker Hannifin cannot assume any liability for product damage caused by moisture from unsealed ends.



WARNING

This product can expose you to chemicals including Antimony Oxide (Antimony Trioxide), which is known to the State of California to cause cancer. For more information go to www.P65Warnings.ca.gov.

How to Specify & Order LT – Light Steam Trace Bundles

Maximum Internal Exposure up to 400°F (204°C)

LT - 2 08 35 B - 2 06 35 - V B

LT	Bundle Type	2	Process Tube Material	08	Process Tube Size	35	Process Tube Size	B	Number of Process Tubes
	LT= Light Trace Temptrace™		1= Smls Copper Type DHP Alloy No 122. ASTM B68/B75 2= Welded Stainless Steel Type 316/316L ASTM A269 3= Welded Stainless Steel Type 304 ASTM A269 B= Smls 316/316L ASTM A269 C= Smls 304 ASTM A269 D= Smls Monel Type 400 E= Smls Hastelloy C22 H= Smls 316H ASTM A213 I= Smls Incoloy 825 L= Electropolish Smls 316/316L ASTM A269 (10Ra Max) M=Smls 316/316L ASTM A213 S= Silco Smls 316/316L Stainless ASTM A269 P= PFA Fluoropolymer F= FEP Fluoropolymer T= TFE Fluoropolymer 7= Parflex 919 PTFE SS Braided Hose 9= Customer Specified Tube Material		O.D. See Charts Imperial 02=1/8" 03=3/16" 04=1/4" 05=5/16" 06=3/8" 07=7/16" 08=1/2" 10=5/8" 12=3/4" 16=1" Metric MA=2mm MB=4mm MC=6mm MD=8mm ME=10mm MF=12mm MG=14mm MH=16mm		Wall Thickness See Charts Imperial 16=.016" 20=.020" 28=.028" 30=.030" 31=.031" 32=.032" 35=.035" 40=.040" 47=.047" 49=.049" 50=.050" 62=.062" 65=.065" 83=.083" Metric 89=.89mm 10=1.0mm 15=1.5mm 20=2.0mm 25=2.5mm		A= 1 Tube B= 2 Tubes C= 3 Tubes etc.

2	Tracer Tube Material	06	Tracer Tube Size	35	Tracer Tube Size	V	Jacket Material	B	Jacket Color
	1= Smls Copper Type DHP Alloy No 122. ASTM B68-B75 2= Welded Stainless Steel Type 316/316L ASTM A269 3= Welded Stainless Steel Type 304 ASTM A269 B= Smls 316/316L ASTM A269 C= Smls 304 ASTM A269 D= Smls Monel Type 400 E= Smls Hastelloy C22 H= Smls 316H ASTM A213 I= Smls Incoloy 825 L= Electropolish Smls 316/316L A269 (10Ra Max) M=Smls 316/316L ASTM A213 S= Silco Smls 316/316L Stainless ASTM A269 P= PFA Fluoropolymer F= FEP Fluoropolymer T= TFE Fluoropolymer 7= Parflex 919 PTFE SS Braided Hose 9= Customer Specified Tube Material		O.D. See Charts Imperial 02=1/8" 03=3/16" 04=1/4" 05=5/16" 06=3/8" 07=7/16" 08=1/2" 10=5/8" 12=3/4" 16=1" Metric MA=2mm MB=4mm MC=6mm MD=8mm ME=10mm MF=12mm MG=14mm MH=16mm		Wall Thickness See Charts Imperial 16=.016" 20=.020" 28=.028" 30=.030" 31=.031" 32=.032" 35=.035" 40=.040" 47=.047" 49=.049" 50=.050" 62=.062" 65=.065" 83=.083" Metric 89=.89mm 10=1.0mm 15=1.5mm 20=2.0mm 25=2.5mm		V=FR-PVC T=FR-TPE U=FR-PUR P=PUR R=TPR E=FRPE L=LDPE F=PVDF Note: Parflex standard jacket material is FR-PVC		N=Black B=Blue G=Green O=Orange Y=Yellow P=Purple R=Red W=White Note: Parflex standard color jacket is black Note: For standard black FR-PVC products the -VN may be dropped.



WARNING

This product can expose you to chemicals including Antimony Oxide (Antimony Trioxide), which is known to the State of California to cause cancer. For more information go to www.P65Warnings.ca.gov.

Performance Data

Light Steam Trace Tubing— Single Process Tube

These performance graphs are based on a 1/4" process tube and a 1/4" tracer tube. Apply run length and temperature correction factors for other process and tracer tube sizes.

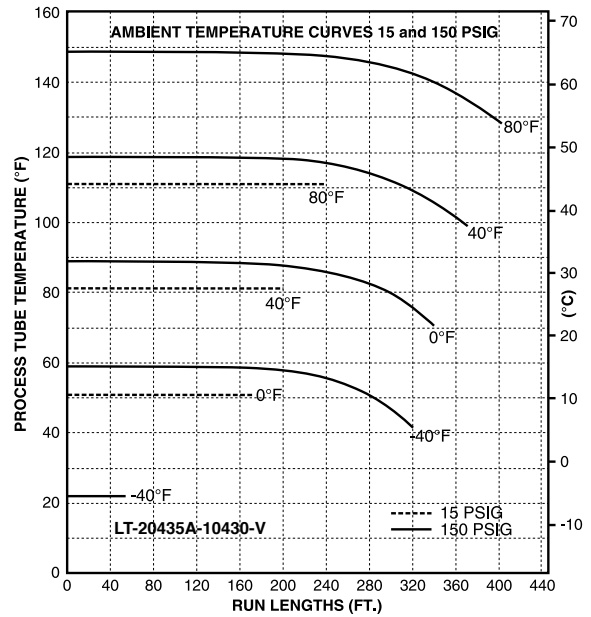
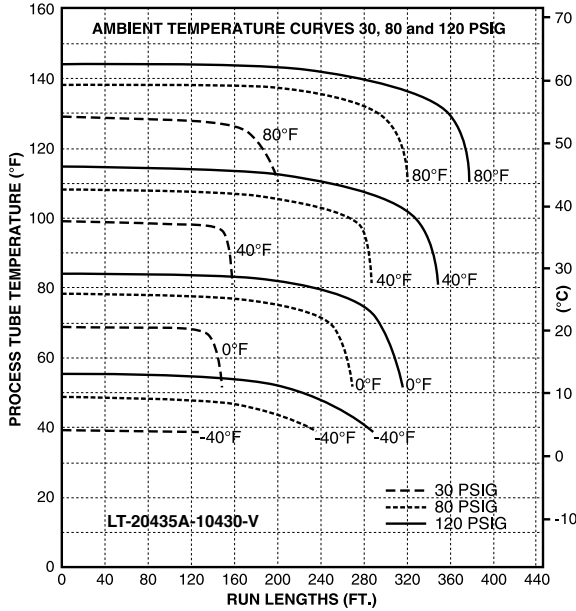

Performance Data

Light Steam Trace Tubing— Multiple Process Tubes

These performance graphs are based on 3/8" process tubes and a 3/8" tracer tube. Apply run length and temperature correction factors for other process and tracer tube sizes.

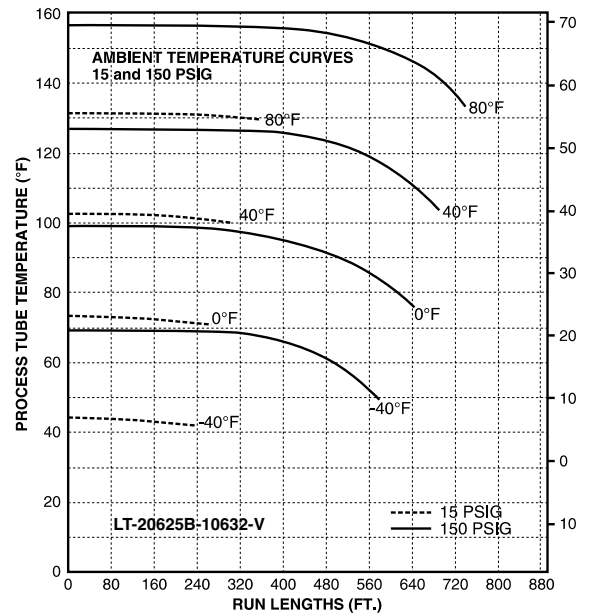
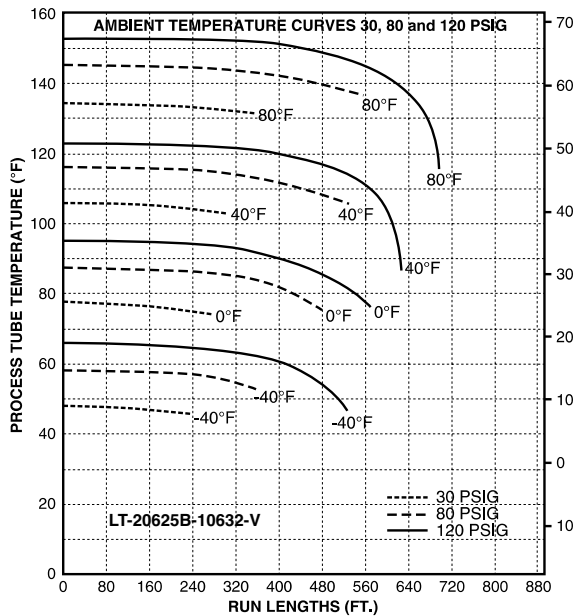

Light Steam Trace Performance Chart

Part Number #	Process Tube O.D. (in.)	Tracer Tube O.D. (in.)	Heat Loss (BTU/hr ft-°F) (DT = 100°F)	Temperature	Run Length (ft.)
	Correction Factors				
Light Trace – Single Process Tube					
LT-20435A-10430	1/4	1/4	10.9	1	1
LT-20635A-10430	3/8	1/4	10.9	0.97	0.9
LT-20835A-10430	1/2	1/4	10.9	0.95	0.8
LT-20635A-10632	3/8	3/8	13.7	–	–
LT-20835A-10632	1/2	3/8	13.7	1.07	1.44
Light Trace – Dual Process Tube					
LT-20435B-10430	(2) 1/4	1/4	10.9	–	–
LT-20635B-10430	(2) 3/8	1/4	10.9	–	–
LT-20835B-10430	(2) 1/2	1/4	10.9	–	–
LT-20635B-10632	(2) 3/8	3/8	13.7	1	1
LT-20835B-10632	(2) 1/2	3/8	13.7	0.98	0.9

LT—Light Steam Trace performance graphs are based upon a 1/4" process tube and a 1/4" tracer tube. Temperature and run length correction factors for other sizes can be determined using the chart provided.

Installation Guide— Light Steam Trace

Part Number #	Process Tube O.D. (in.)	Tracer Tube O.D.(in.)	Nominal Product O.D. (in.)	Product Weight (lbs./ft.)	Minimum Bend Radius (in.)	Horizontal/ Vertical Support Centers (ft.)	Slope
	Welded Stainless*	Copper					
Light Trace-Single Process Tube							
LT-20435A-10430	1/4	1/4	1.3	.385	10	5-6' 10-15'	1" in 8'
LT-20635A-10430	3/8	1/4	1.4	.453	12	5-6' 10-15'	1" in 6'
LT-20835A-10430	1/2	1/4	1.5	.519	14	5-6' 10-15'	1" in 3'
LT-20635A-10632	3/8	3/8	1.5	.531	12	5-6' 10-15'	1" in 7'
LT-20835A-10632	1/2	3/8	1.6	.598	14	5-6' 10-15'	1" in 6'
Light Trace-Dual Process Tube							
LT-20435B-10430	(2) 1/4	1/4	1.3	.473	14	5-6' 10-15'	1" in 8'
LT-20635B-10430	(2) 3/8	1/4	1.5	.599	15	5-6' 10-15'	1" in 6'
LT-20835B-10430	(2) 1/2	1/4	1.6	.778	16	5-6' 10-15'	1" in 3'
LT-20635B-10632	(2) 3/8	3/8	1.6	.675	16	5-6' 10-15'	1" in 7'
LT-20835B-10632	(2) 1/2	3/8	1.7	.803	18	5-6' 10-15'	1" in 6'

*Available in seamless stainless steel and other alloys



WARNING

This product can expose you to chemicals including Antimony Oxide (Antimony Trioxide), which is known to the State of California to cause cancer. For more information go to www.P65Warnings.ca.gov.

HT— Heavy Steam Trace

Maximum Internal Exposure Temperature up to 400°F (204°C)



General

Parflex HT—Heavy Steam Trace Tubing consists of a single process tube and tracer, non-hygroscopic glass fiber insulation and a black, 105°C-rated, flame-resistant PVC (FR-PVC) jacket.

HT—Heavy Steam Trace Tubing is designed to be used with steam pressures of 15 PSIG (1 BAR) to 230 PSIG (15.8 BAR) and maintain process tube temperatures from 200°F (93°C), at -40°F (-40°C) ambient, to 355°F (179°C), at 80°F (26.6°C) ambient, with product surface temperatures of less than 140°F (60°C) at 80°F (26.6°C) ambient. Standard product has a Maximum Temperature Rating (MTR*) of 400°F (204.4°C). Higher temperature rated designs are available; consult Division for details.

*Maximum Temperature Rating is the maximum allowable temperature of the tracing fluid. Temperatures in excess of this may damage the product or alter its performance.

Applications

HT—Heavy Steam Trace Tubing is used with high temperature steam to heat trace instrument size lines when elevated temperatures are required. Such applications as pressure transmission and analyzer sample lines carrying heavy oils or distillates, gases or vapors are ideal service for the HT—Heavy Steam Trace Tubing products. The direct tracer to process tube contact produces higher process tube temperatures than the light trace product.

Tubing

Type 122 DHP Seamless Copper and 316/316L Welded Stainless Steel are standard. Additional materials, wall thicknesses and seamless stainless steel are available upon request. For Material Specifications of metal tubing, see *Technical Data* section of the catalog. Consult Division for details.

Tubing Identification

When the process tube and tracer tube are the same size and material, each individual tube is printed with a tube number at two-inch intervals.

Insulation

Air-spaced, cross wrapped applied non-hygroscopic fiberglass thermal insulation provides minimum heat loss.

Jacket

The tough, black, 105°C-rated, flame-resistant PVC (FR-PVC) jacket protects the tubing against corrosive atmospheres, water, oils, acids, alkalis and most chemicals. Additional jacket materials are available upon request. For Material Specifications of jackets, see *Technical Data* section of the catalog. Consult Division for additional details.

Testing

Each tube in every length of Parflex Temptrace™ is pressure tested prior to shipment to assure the instrument engineer a high-quality, reliable, trouble-free product. For Testing Specifications, see *Technical Data* Section of the catalog.

Accessories

Accessories are available for connecting multiple lengths of steam trace bundles and sealing bundle ends.

NOTE: It is absolutely necessary to seal the ends against contamination from moisture and/or corrosive liquids. Parker Hannifin cannot assume any liability for product damage caused by moisture from unsealed ends.



WARNING

This product can expose you to chemicals including Antimony Oxide (Antimony Trioxide), which is known to the State of California to cause cancer. For more information go to www.P65Warnings.ca.gov.

How to Specify & Order

HT – Heavy Steam Trace Bundles

Maximum Internal Exposure up to 400°F (204°C)

HT - 2 08 35 B - 2 06 35 - V B

HT	Bundle Type HT= Heavy Trace Temptrace™	2	Process Tube Material	08	Process Tube Size	35	Process Tube Size	B	Number of Process Tubes
			1= Smls Copper Type DHP Alloy No 122. ASTM B68/B75 2= Welded Stainless Steel Type 316/316L ASTM A269 3= Welded Stainless Steel Type 304 ASTM A269 B= Smls 316/316L ASTM A269 C= Smls 304 ASTM A269 D= Smls Monel Type 400 E= Smls Hastelloy C22 H= Smls 316H ASTM A213 I = Smls Incoloy 825 L= Electropolish Smls 316/316L ASTM A269 (10Ra Max) M=Smls 316/316L ASTM A213 S= Silco Smls 316/316L Stainless ASTM A269 P= PFA Fluoropolymer F= FEP Fluoropolymer T= TFE Fluoropolymer 7= Parflex 919 PTFE SS Braided Hose 9= Customer Specified Tube Material		O.D. See Charts Imperial 02=1/8" 03=3/16" 04=1/4" 05=5/16" 06=3/8" 07=7/16" 08=1/2" 10=5/8" 12=3/4" 16=1" Metric MA=2mm MB=4mm MC=6mm MD=8mm ME=10mm MF=12mm MG=14mm MH=16mm		Wall Thickness See Charts Imperial 16=.016" 20=.020" 28=.028" 30=.030" 31=.031" 32=.032" 35=.035" 40=.040" 47=.047" 49=.049" 50=.050" 62=.062" 65=.065" 83=.083" Metric 89=.89mm 10=1.0mm 15=1.5mm 20=2.0mm 25=2.5mm		A= 1 Tube B= 2 Tubes C= 3 Tubes etc.

2	Tracer Tube Material	06	Tracer Tube Size	35	Tracer Tube Size	V	Jacket Material	B	Jacket Color
	1= Smls Copper Type DHP Alloy No 122. ASTM B68-B75 2= Welded Stainless Steel Type 316/316L ASTM A269 3= Welded Stainless Steel Type 304 ASTM A269 B= Smls 316/316L ASTM A269 C= Smls 304 ASTM A269 D= Smls Monel Type 400 E= Smls Hastelloy C22 H= Smls 316H ASTM A213 I = Smls Incoloy 825 L= Electropolish Smls 316/316L A269 (10Ra Max) M=Smls 316/316L ASTM A213 S= Silco Smls 316/316L Stainless ASTM A269 P= PFA Fluoropolymer F= FEP Fluoropolymer T= TFE Fluoropolymer 7= Parflex 919 PTFE SS Braided Hose 9= Customer Specified Tube Material		O.D. See Charts Imperial 02=1/8" 03=3/16" 04=1/4" 05=5/16" 06=3/8" 07=7/16" 08=1/2" 10=5/8" 12=3/4" 16=1" Metric MA=2mm MB=4mm MC=6mm MD=8mm ME=10mm MF=12mm MG=14mm MH=16mm		Wall Thickness See Charts Imperial 16=.016" 20=.020" 28=.028" 30=.030" 31=.031" 32=.032" 35=.035" 40=.040" 47=.047" 49=.049" 50=.050" 62=.062" 65=.065" 83=.083" Metric 89=.89mm 10=1.0mm 15=1.5mm 20=2.0mm 25=2.5mm		V=FR-PVC T=FR-TPE U=FR-PUR P=PUR R=TPR E=FRPE L=LDPE F=PVDF Note: Parflex standard jacket material is FR-PVC		N=Black B=Blue G=Green O=Orange Y=Yellow P=Purple R=Red W=White Note: Parflex standard color jacket is black Note: For standard black FR-PVC products the -VN may be dropped.



WARNING

This product can expose you to chemicals including Antimony Oxide (Antimony Trioxide), which is known to the State of California to cause cancer. For more information go to www.P65Warnings.ca.gov.

Performance Data

HT— Heavy Steam Trace Tubing — Single Process Tubes

These performance graphs are based on a 1/4" process tube and a 1/4" tracer tube. Apply run length and temperature correction factors for other process and tracer tube sizes.

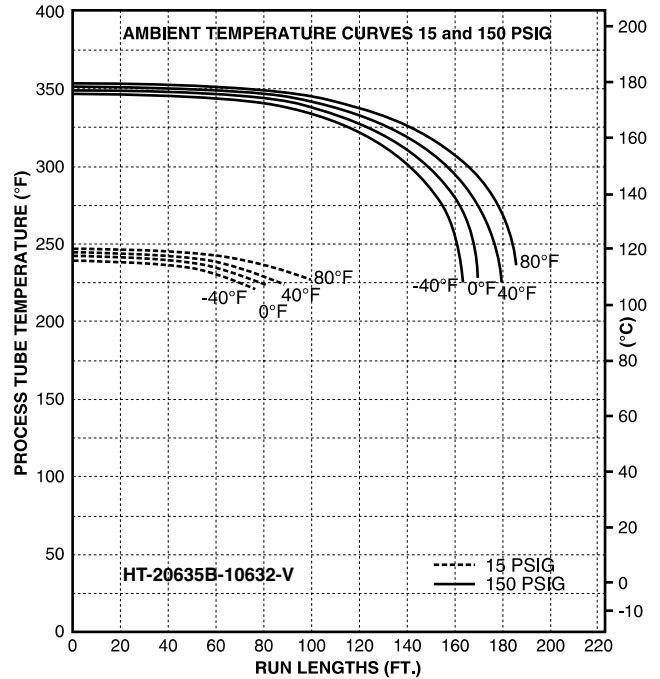
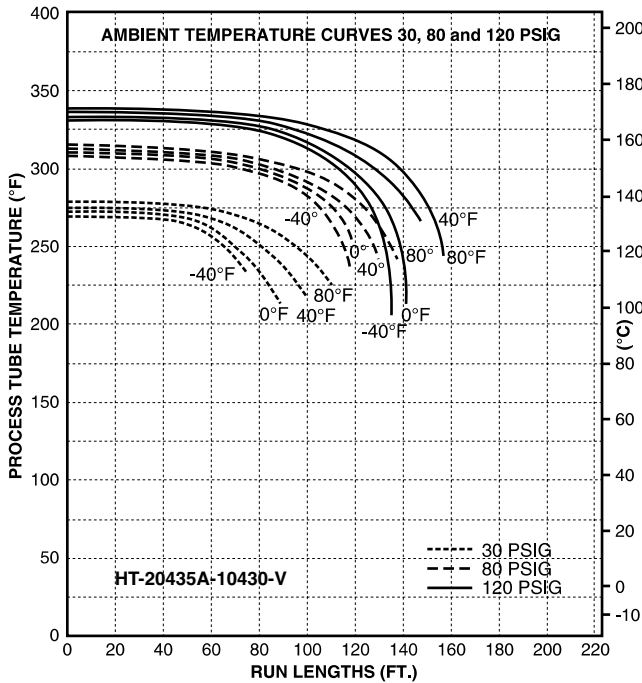



Performance Data

HT— Heavy Steam Trace Tubing — Multiple Process Tubes

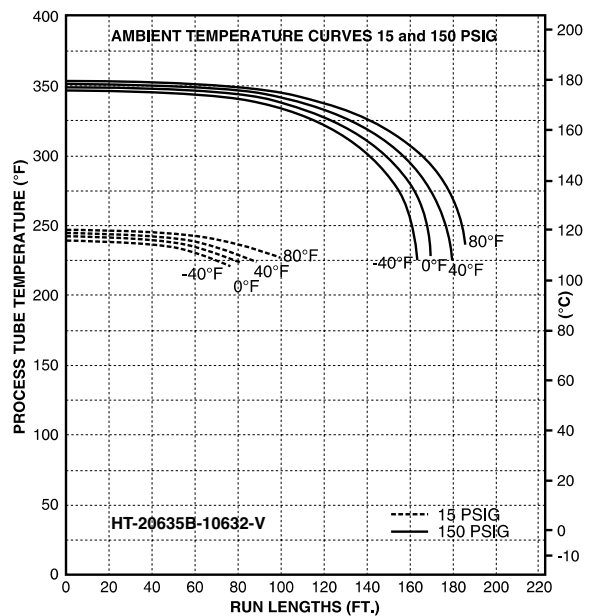
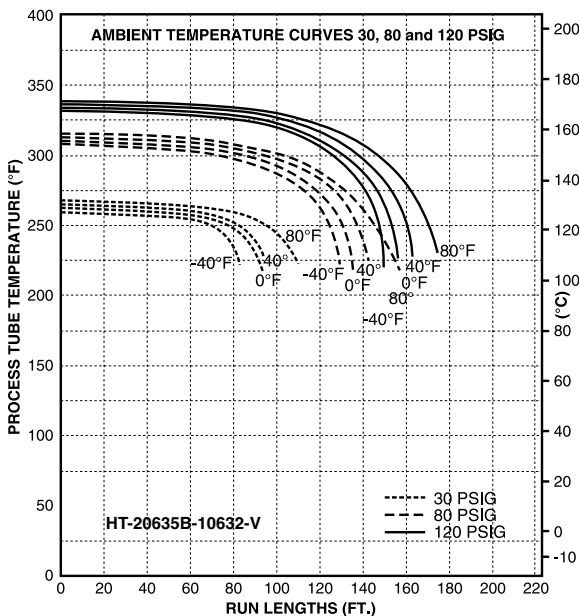
These performance graphs are based on 3/8" process tubes and a 3/8" tracer tube. Apply run length and temperature correction factors for other process and tracer tube sizes.









Heavy Steam Trace Performance Chart

Part Number #	Process Tube O.D.	Tracer Tube O.D.	Heat Loss (BTU/hr ft-°F) (DT = 100°F)	Temperature	Run Length (ft.)
				Correction Factor	
Heavy Trace-Single Process Tube					
HT-20435A-10430	1/4	1/4	15.3	1	1
HT-20635A-10430	3/8	1/4	18.3	0.995	0.85
HT-20835A-10430	1/2	1/4	20.7	0.99	0.76
HT-20635A-10632	3/8	3/8	19.9	1.06	2.09
HT-20835A-10632	1/2	3/8	23.1	1.04	2.05
Heavy Trace-Dual Process Tube					
HT-20435B-10430	(2) 1/4	1/4	18	--	--
HT-20635B-10430	(2) 3/8	1/4	21.9	--	--
HT-20835B-10430	(2) 1/2	1/4	25.8	--	--
HT-20635B-10632	(2) 3/8	3/8	25.8	1	1
HT-20835B-10632	(2) 1/2	3/8	27.7	0.996	0.90

HT—Heavy Steam Trace performance graphs are based upon a 1/4" process tube and a 1/4" tracer tube. Temperature and run length correction factors for other sizes can be determined using the chart provided

Installation Guide— Heavy Steam Trace

Part Number #	Process Tube O.D. (in.)	Tracer Tube O.D. (in.)	Nominal Product O.D. (in.)	Product Weight (lbs./ft.)	Minimum Bend Radius (in.)	Horizontal/Vertical Support Centers (ft.)	Slope
							
Heavy Trace – Single Process Tube							
HT-20435A-10430	1/4	1/4	1.1	.376	8	5-6' 10-15'	1" in 8'
HT-20635A-10430	3/8	1/4	1.3	.446	10	5-6' 10-15'	1" in 6'
HT-20835A-10430	1/2	1/4	1.4	.520	12	5-6' 10-15'	1" in 3'
HT-20635A-10632	3/8	3/8	1.3	.526	12	5-6' 10-15'	1" in 7'
HT-20835A-10632	1/2	3/8	1.5	.594	14	5-6' 10-15'	1" in 6'
Heavy Trace – Dual Process Tube							
HT-20435B-10430	(2) 1/4	1/4	1.2	.479	12	5-6' 10-15'	1" in 8'
HT-20635B-10430	(2) 3/8	1/4	1.4	.608	13	5-6' 10-15'	1" in 6'
HT-20835B-10430	(2) 1/2	1/4	1.6	.743	13	5-6' 10-15'	1" in 3'
HT-20635B-10632	(2) 3/8	3/8	1.5	.682	13	5-6' 10-15'	1" in 7'
HT-20835B-10632	(2) 1/2	3/8	1.7	.812	14	5-6' 10-15'	1" in 6'



WARNING

This product can expose you to chemicals including Antimony Oxide (Antimony Trioxide), which is known to the State of California to cause cancer. For more information go to www.P65Warnings.ca.gov.

Steam Trace Accessory Selections

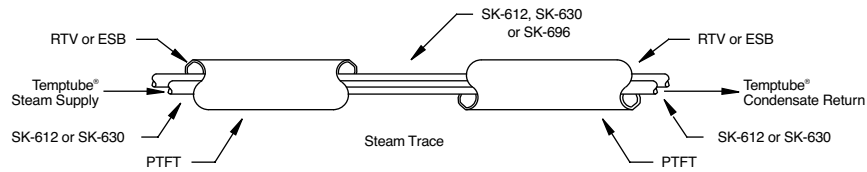

End Sealant

Parflex end sealant is a paste material which becomes a tough, rubbery seal upon exposure to air. Total curing takes about 24 hours, at which time it has excellent resistance to weather, ozone, oil, many chemicals and extreme temperatures “-75°F (-60°C) to +400°F (204.4°C). High temperature sealant to 500°F (260°C) available.

To order: Specify Parflex room temperature vulcanizing (RTV) end sealant part numbers:

Important: All Parflex steam products must have sealed ends to prevent contamination of insulation. Parflex product ends are sealed at the factory and it is important that these seals be maintained during storage and that they are sealed upon installation. We will not assume liability for any corrosion or damage to the product caused by such contamination.



RTV-103BLK
– 2.8 oz. tube, 400°F (204.4°C) rated



RTV-103BLK10.3
– 10.3 oz. cartridge, 400°F (204.4°C) rated



RTV-106RED – 2.8 oz. tube, high temperature 500°F (260°C)

Heat Shrinkable Boots (HSBs)

Parflex heat shrink boots (HSB) are designed to prevent moisture from entering the ends of Parflex Temptrace™ bundles. The dash number represents the number of breakouts in each boot. The boots can be used on 1/4", 3/8", or 1/2" tubes, or as a seal for the heating cable.



HSB-2



HSB-1

PTFT Feed-Through Seal Kits

Selected specifically for use with Parflex Temptrace™ and Temptube® bundles. PTFT kits provide an excellent method in which to install Parflex Temptrace™ and Temptrace™ bundles in instrument enclosures and cabinets.



PTFT – 1.50



PTFT – 2.00



WARNING

This product can expose you to chemicals including Antimony Oxide (Antimony Trioxide), which is known to the State of California to cause cancer, and Ethylene Oxide, which is known to the State of California to cause birth defects or other reproductive harm. For more information go to www.P65Warnings.ca.gov.

End Seal Boot (ESB) Kit

Parflex end seal boot (ESB) kits are designed to prevent moisture from entering the ends of Parflex Temtrace™ bundles. Each boot allows up to three tube breakouts. These breakouts have marks to specify where to cut for either a 1/4", 3/8" and 1/2" tube.

Each Kit contains:

- (2) End Seal Boots
- (6) Stainless Steel Hose Clamps
- (2) Plastic Hose Clamps (1.47" - 1.72")
- (2) Plastic Hose Clamps (1.73"-2.02")
- (2) Mastic Sealant (3/4" wide x 9" long)

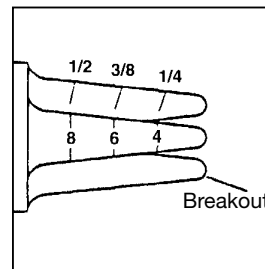

Temptube® End Seal Kit (ESK)

Parflex End Seal Kits (ESK) are designed to prevent moisture from entering the ends of Parflex Temptube® bundles. Kits come in different sizes for 1/4", 3/8" and 1/2" tubes. Each kit contains enough components to seal ten ends.

Each kit contains:

- (10) Silicone Grommets
- (10) Plastic Hose Clamps



Splice Kit SK-612

The SK-612 has been designed to provide long life, weatherproof thermal insulation and jacket over a tube fitting or instrument connection.

There is sufficient material in each SK-612 Splice Kit to insulate two (2) splices or bundle ends.

Each Kit contains:

- (2) 8"x 8" self-sealing rubber sheets with a 6" x 12" fiberglass pad.
- (1) Roll waterproof sealing tape.



Splice Kit SK-630

The SK-630 has been designed to provide long life, weatherproof thermal insulation and jacket over a tube fitting or instrument connection.

There is sufficient material in each SK-612 Splice Kit to insulate two (2) splices or bundle ends.

Each Kit contains:

- (2) 8"x 30" self-sealing rubber sheets with a 6" x 30" fiberglass pad.
- (1) Roll waterproof sealing tape.



Splice Kit SK-696

The SK-696 has been designed to provide long life, weatherproof thermal insulation and jacket for longer lengths up to 96" (8ft.) of bundles or multiple connections.

Each Kit contains:

- (1) Roll 8" x 96" self-sealing rubber sheet.
- (1) Roll 6" x 96" fiberglass pad.
- (1) Roll waterproof sealing tape.



WARNING

This product can expose you to chemicals including Antimony Oxide (Antimony Trioxide), which is known to the State of California to cause cancer, and Ethylene Oxide, which is known to the State of California to cause birth defects or other reproductive harm. For more information go to www.P65Warnings.ca.gov.

Parker Steam Trace Design Criteria Quote Request

Fax Inquiry To: Sales Office
330-296-1829

Date: _____ Customer Name: _____

Bundle Type: Light Trace (Low Temperature Maintenance and Freeze Protection)
 Heavy Trace (High Temperature Maintenance)

Total Quantity: _____ Feet
 Meters

Specified Lengths: _____

Part Number: _____ (See How-to-Order in catalog.)

If not sure of part number, complete the following criteria:

Maximum Steam Pressure: _____

Maximum Steam Temperature: _____

Process Tubes:

How many process tubes: _____

Size: (O.D. and wall thickness): _____ Inches
 mm

Tube Material: _____

Trace Tube:

Size: (O.D. and wall thickness): _____ Inches
 mm

Tube Material: _____

Outer Jacket Type: (Note: Black FR-PVC is Standard)

- | | |
|---------------------------------|-------------------------------|
| FR-PVC <input type="checkbox"/> | TPR <input type="checkbox"/> |
| FR-TPE <input type="checkbox"/> | FRPE <input type="checkbox"/> |
| FR-PUR <input type="checkbox"/> | LDPE <input type="checkbox"/> |
| PUR <input type="checkbox"/> | PVDF <input type="checkbox"/> |



WARNING

This product can expose you to chemicals including Antimony Oxide (Antimony Trioxide), which is known to the State of California to cause cancer. For more information go to www.P65Warnings.ca.gov.

SL – Self-Regulating Low Temperature Maintenance Bundles

Maintain Temperatures up to 150°F (65°C) and withstands
Maximum Internal Exposure to 185°F (85°C)



General

Parflex Temprace™ tubing is thermally insulated with a non-hygroscopic inorganic fiberglass material and protected with a flexible, black, flame-resistant PVC jacket.

Parflex standard Temprace™ is thermally insulated for transfer of fluids or gases up to 185°F (85°C) while maintaining an outer jacket surface temperature of 140°F (60°C), meeting NEC Personnel Protection Code 427.12.

SL-Temprace™ is designed to provide freeze protection and low-temperature maintenance for gases, liquids or other viscous materials. With outdoor temperatures of -40°F (-40°C), SL-Temprace™ will maintain a process fluid or gas at 40°F (4.4°C).

SL- Temprace™ can maintain process tube temperatures up to 140°F (60°C), depending upon ambient conditions.

Heating Cables

Cables are available in 120V and 208-277 volt, with Heat outputs of 3, 5, 8 and 10 watt/ft.

SL-Temprace™ is rated per NEC standards. Cables with heat outputs of 3, 5 and watts/ft have a T3 rating. Cables with heat outputs of 10, 15 and 20 watts/ft have a T2D rating.

Parflex standard SL designs come with an internal tinned copper braid on the heating cable for grounding purposes and a TPR jacket over the heating cable to provide additional protection against many inorganic chemical solutions.

Common Tube Materials and Sizes

Temprace™ is readily available in 1/4", 3/8" and 1/2" sizes as well as metric sizes (6 mm, 8mm, 10mm and 12mm). The most common stock alloys are Seamless Copper Type 122 DHP ASTM B68-B75, as well as seamless and welded stainless steel tubing, Type 316/316L ASTM A269. Many other alloys, ASTM standards and sizes are available upon request. (See *Technical Data* Section)

Testing

All Temprace™ products are pressure tested prior to shipment. Third party testing and witnessing is available upon request, including DNV, ABS and Lloyd's Register. Contact factory for complete details.

Jacketing Materials

Black, UV-resistant, FR-PVC is our standard material, however, other jacketing materials are available upon request, including non-halogenated FR-TPE and Urethanes. (See *Technical Data* Section)

NOTE: It is absolutely necessary to seal the ends against contamination from moisture and/or corrosive liquids. Parker Hannifin cannot assume any liability for product damage caused by moisture from unsealed ends.



WARNING

This product can expose you to chemicals including Antimony Oxide (Antimony Trioxide), which is known to the State of California to cause cancer. For more information go to www.P65Warnings.ca.gov.

How to Specify & Order SL-Self-Regulating Low Temperature Maintenance Electric Trace Bundles: MTR* 185°F (85°C)

Maintain Temperatures up to 150°F (65°C) with a *Maximum Internal Exposure up to 185°F (85°C)

SL - 3 1 2 - B 08 35 B - V B





SL	Bundle Type	3	Heating Cable (Watts/ft)	1	Heating Cable Voltage	2	Area Classification	B	Process Tube Material
	SL= Self-Regulating Low Temperature		See Selection Chart 3= 3watt 5= 5watt 8= 8watt 1= 10 watt		1= 120V 2= 240V * 240 volt cables can be powered at 208, 240 or 277 volts		1= Class 1, Div. 1 Areas 2= General Purpose & Class 1, Div. 2 Areas		1= Smls Copper Type DHP Alloy No 122. ASTM B68/B75 2= Welded Stainless Steel Type 316/316L ASTM A269 3= Welded Stainless Steel Type 304 ASTM A269 B= Smls 316/316L ASTM A269 C= Smls 304 ASTM A269 D= Smls Monel Type 400 E= Smls Hastelloy C22 H= Smls 316H ASTM A213 I = Smls Incoloy 825 L= Electropolish Smls 316/316L ASTM A269 (10Ra Max) M=Smls 316/316L ASTM A213 S= Silco Smls 316/316L Stainless ASTM A269 P= PFA Fluoropolymer F= FEP Fluoropolymer T= TFE Fluoropolymer 7= Parflex 919 PTFE SS Braided Hose 9= Customer Specified Tube Material

08	Process Tube Size	35	Process Tube Size	B	Number of Process Tubes	V	Jacket Material	B	Jacket Color
	O.D. See Charts Imperial 02=1/8" 03=3/16" 04=1/4" 05=5/16" 06=3/8" 07=7/16" 08=1/2" 10=5/8" 12=3/4" 16=1" Metric MA=2mm MB=4mm MC=6mm MD=8mm ME=10mm MF=12mm MG=14mm MH=16mm		Wall Thickness See Charts Imperial 16=.016" 20=.020" 28=.028" 30=.030 31=.031" 32=.032" 35=.035" 40=.040" 47=.047" 49=.049" 50=.050" 62=.062" 65=.065" 83=.083" Metric 89=.89mm 10=1.0mm 15=1.5mm 20=2.0mm 25=2.5mm		A= 1 Tube B= 2 Tubes C= 3 Tubes etc. P= 2 Tube Parallel Design		V=FR-PVC T=FR-TPE U=FR-PUR P=PUR R=TPR E=FRPE L=LDPE F=PVDF Note: Parflex standard jacket material is FR-PVC		N=Black B=Blue G=Green O=Orange Y=Yellow P=Purple R=Red W=White Note: Parflex standard color jacket is black Note: For standard black FR-PVC jacketed products the -VN may be dropped.



WARNING

This product can expose you to chemicals including Antimony Oxide (Antimony Trioxide), which is known to the State of California to cause cancer. For more information go to www.P65Warnings.ca.gov.

Part Number #	Process Tube O.D. (in.)	Wall Thickness (in.)	Nominal Product O.D. (in.)	Product Weight (lbs./ft.)	Minimum Bend Radius (in.)	Watt Density per foot / Voltage**	Circuit Length Ft @ 50°F Start-up / Breaker (amps)	Performance At Various Ambient Conditions	
	Smls Stainless*					Watt/Ft		At -40°F (-40°C) will maintain at least***	At 80°F (23.9°C) will maintain at least***
SL – Single Process Tube – Maximum Internal Exposure Temperature, Power off 185°F (85°C)									
SL512-B0435A	1/4	0.035	1.21	0.33	7	5 watt / 120V	270ft / 25A	40°F [4°C]	120°F [49°C]
SL512-B0635A	3/8	0.035	1.31	0.39	8	5 watt / 120V	270ft / 25A	40°F [4°C]	115°F [46°C]
SL512-B0835A	1/2	0.035	1.41	0.46	8	5 watt / 120V	270ft / 25A	40°F [4°C]	115°F [46°C]
SL812-B1249A	3/4	0.049	1.64	0.68	10	8 watt / 120V	215ft / 25A	40°F [4°C]	125°F [52°C]
SL – Dual Process Tubes – Maximum Internal Exposure Temperature, Power off 185°F (85°C)									
SL512-B0435B	(2) 1/4	0.035	1.28	0.42	8	5 watt / 120V	270ft / 25A	40°F [4°C]	115°F [46°C]
SL512-B0635B	(2) 3/8	0.035	1.43	0.54	9	5 watt / 120V	270ft / 25A	40°F [4°C]	115°F [46°C]
SL812-B0835B	(2) 1/2	0.035	1.61	0.66	10	8 watt / 120V	215ft / 25A	40°F [4°C]	125°F [52°C]
SL812-B1239B	(2) 3/4	0.049	1.99	1.11	12	8 watt / 120V	215ft / 25A	40°F [4°C]	120°F [49°C]

*Many other alloys available in addition to seamless stainless steel tubing.

**Product is also available in 208, 240 and 277V

***In some cases, without use of a controller, this design could maintain higher temperatures at the ambient temperature shown. The temperature maintained is based upon the watt density heater shown, higher watt density heaters could be used to achieve a greater maintenance temperatures.

FM – Factory Mutual

General Purpose - Ordinary Locations
Hazardous Locations, when installed with Parflex accessories.

- Class I, Div. 2, Groups B, C and D (gases, vapors)
- Class II, Div.2, Group F, G (Combustible dust)
- Class III, Div.2, (ignitable fibers and filings)

T-Temperature Ratings

- 3 watt rated T6 temperature class
- 5 and 8 watt rated T5 temperature class
- 10 watt rated T4A temperature class

CSA – Canadian Standards Association

CSA Certified for ordinary locations
For certified hazardous locations contact Parflex

ATEX - Certified cables & accessories available

Electrical Specifications:

Operating Voltage: 120 V or 240V
Bus Wire Voltage Rating: 600 Volts
Bus Wire Size: 16 AWG

Maximum Circuit Length (ft) at Start-up °F

Low-Temp Cable Rating	50°F (10°C) Circuit Length In Feet				0°F (-18°C) Circuit Length In Feet				-20°F (-29°C) Circuit Length In Feet			
	10	20	25	30	10	20	25	30	10	20	25	30
Circuit Breaker Size [Amps]												
3 watt / 120V	205	360	NR	NR	135	270	330	360	120	245	300	360
3 watt / 240V	400	660	NR	NR	275	555	660	NR	245	495	600	660
5 watt / 120V	125	250	270	NR	90	180	225	270	80	160	205	245
5 watt / 240V	250	505	540	NR	180	360	450	540	160	325	405	490
8 watt / 120V	100	200	215	NR	70	145	180	215	65	235	300	350
8 watt / 240V	185	375	420	NR	135	265	335	395	120	325	300	350
10 watt / 120V	60	130	160	180	50	105	130	155	45	95	120	140
10 watt / 240V	100	210	260	315	80	170	210	255	75	160	195	240



WARNING

This product can expose you to chemicals including Antimony Oxide (Antimony Trioxide), which is known to the State of California to cause cancer. For more information go to www.P65Warnings.ca.gov.

Performance Data—Single Process Tube

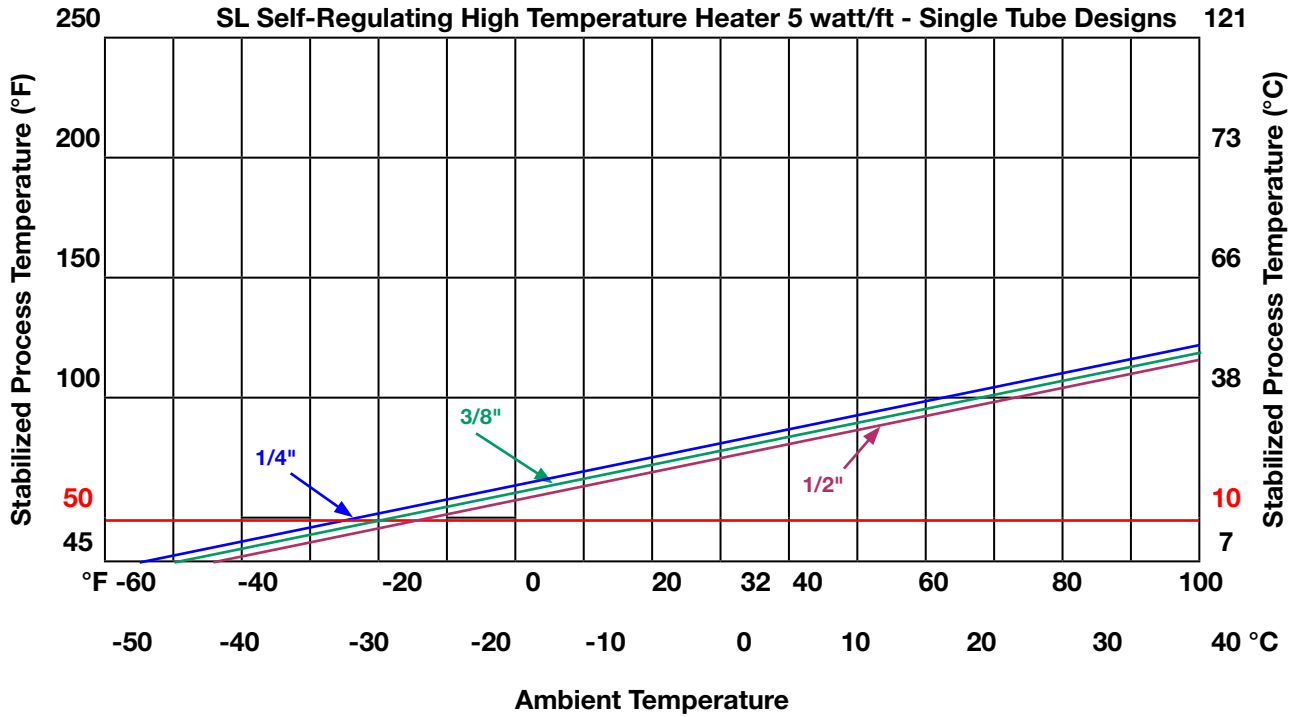

Performance Data—Dual Process Tube

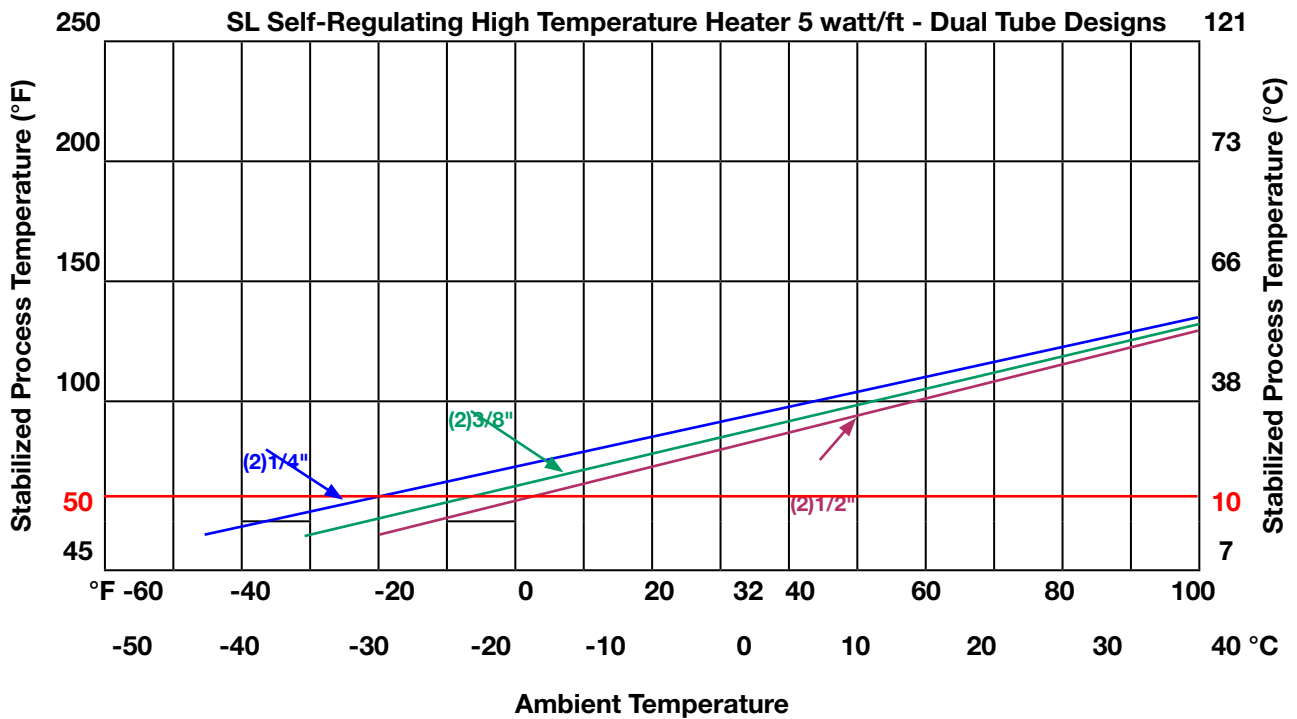

SL Series Self-Regulating Bundles Maximum Exposure 185°F (85°C) Process Tubes 1/4" to 1/2" O.D. (6mm to 12mm) Single or Dual Tube Designs					
Minimum Process Temperature to Maintain**	Standard Insulation Package*				
	Environments Average High / Low Ambient Conditions				
	Extreme Cold	Cold	Moderate Cold	Moderate	Warm
	-65°F Low 80°F High	-40°F Low 80°F High	-10°F Low 95°F High	0°F Low 105°F High	10°F Low 115°F High
120 Volts	-54°C Low 26°C High	-40°C Low 26°C High	-24°C Low 35°C High	-18°C Low 40°C High	-13°C Low 46°C High
40°F (4°C)	8 Watt / Ft	8 Watt / Ft	5 Watt / Ft	3 Watt / Ft	3 Watt / Ft
50°F (10°C)	10 Watt / Ft	8 Watt / Ft	5 Watt / Ft	5 Watt / Ft	3 Watt / Ft
75°F (24°C)			8 Watt / Ft	8 Watt / Ft	8 Watt / Ft
208 Volts					
40°F (4°C)	10 Watt / Ft	8 Watt / Ft	5 Watt / Ft	5 Watt / Ft	3 Watt / Ft
50°F (10°C)		10 Watt / Ft	8 Watt / Ft	8 Watt / Ft	5 Watt / Ft
75°F (24°C)				10 Watt / Ft	8 Watt / Ft
240 Volts					
40°F (4°C)	8 Watt / Ft	8 Watt / Ft	5 Watt / Ft	3 Watt / Ft	3 Watt / Ft
50°F (10°C)	10 Watt / Ft	8 Watt / Ft	5 Watt / Ft	5 Watt / Ft	3 Watt / Ft
75°F (24°C)			8 Watt / Ft	8 Watt / Ft	8 Watt / Ft

* The above heater cable selection is based upon our standard insulation package, other insulation packages are available to maintain higher temperatures.

** The maintenance temperature could actually be higher depending upon the size and number of tubes required. For precise temperature control, it is recommended that a thermal sensor be used. Contact the factory for more exact product thermal properties based upon your application conditions.

How to Use:

- 1) Check to be sure you are using the correct chart.
- 2) Choose your operating voltage.
- 3) Choose the minimum process temperature you want to maintain. Note: If temperature is not shown, pick the next higher option.
- 4) Follow chart across to the ambient Condition that best match your area.
- 5) Use the watt-density shown for your part number derivation.

Note:

The watt-density selected will maintain the temperature indicated at a minimum. Depending upon actual ambient fluctuations, process tubes size and number of tubes, the maintenance temperature could be higher.

SL Series Self-Regulating Bundles
Maximum Exposure 185°F (85° C)
Process Tubes 3/4" to 1" O.D. (19mm to 25mm)
Single Tube Designs (consult factory for multiple tubes)

Minimum Process Temperature to Maintain**	Standard Insulation Package *				
	Environments Average High / Low Ambient Conditions				
	Extreme Cold	Cold	Moderate Cold	Moderate	Warm
	-65°F Low 80°F High	-40°F Low 80°F High	-10°F Low 95°F High	0°F Low 105°F High	10°F Low 115°F High
120 Volts	-54°C Low 26°C High	-40°C Low 26°C High	-24°C Low 35°C High	-18°C Low 40°C High	-13°C Low 46°C High
40°F (4°C)	10 Watt / Ft	8 Watt / Ft	5 Watt / Ft	5 Watt / Ft	3 Watt / Ft
50°F (10°C)		10 Watt / Ft	8 Watt / Ft	5 Watt / Ft	5 Watt / Ft
75°F (24°C)			10 Watt / Ft	10 Watt / Ft	8 Watt / Ft
208 Volts					
40°F (4°C)		10 Watt / Ft	8 Watt / Ft	5 Watt / Ft	5 Watt / Ft
50°F (10°C)		10 Watt / Ft	8 Watt / Ft	8 Watt / Ft	5 Watt / Ft
75°F (24°C)					10 Watt / Ft
240 Volts					
40°F (4°C)	10 Watt / Ft	8 Watt / Ft	5 Watt / Ft	5 Watt / Ft	3 Watt / Ft
50°F (10°C)		10 Watt / Ft	8 Watt / Ft	5 Watt / Ft	5 Watt / Ft
75°F (24°C)			10 Watt / Ft	10 Watt / Ft	8 Watt / Ft

* The above heater cable selection is based upon our standard insulation package, other insulation packages are available to maintain higher temperatures.

** The maintenance temperature could actually be higher depending upon the size and number of tubes required. For precise temperature control, it is recommended that a thermal sensor be used. Contact the factory for more exact product thermal properties based upon your application conditions.

How to Use:

- 1) Check to be sure you are using the correct chart.
- 2) Choose your operating voltage.
- 3) Choose the minimum process temperature you want to maintain. Note: If temperature is not shown, pick the next higher option.
- 4) Follow chart across to the ambient Condition that best match your area.
- 5) Use the watt-density shown for your part number derivation.

Note:

The watt-density selected will maintain the temperature indicated at a minimum. Depending upon actual ambient fluctuations, process tubes size and number of tubes, the maintenance temperature could be higher.

SH – Self-Regulating High Temperature Maintenance Bundles

Maintain Temperatures up to 250°F (121°C) and withstands an Internal Exposure Temperature of 400°F (204°C)



General

Parflex Temprace™ tubing is thermally insulated with a non-hygroscopic, inorganic fiberglass material and protected with a flexible, black, flame-resistant PVC jacket.

Parflex standard Temprace™ is thermally insulated for transfer of fluids or gases up to 400°F (204°C) while maintaining an outer jacket surface temperature of 140°F (60°C), meeting NEC Personnel Protection Code 427.12.

SH- Temprace™ is designed to provide temperature maintenance for gases, liquids or other process materials. The high temperature self-regulating product has a maximum temperature rating of 250°F (121.1°C), when power to the heating cable is on, and can be steam cleaned at 400°F (204°C), when power to the heating cable is off.

SH- Temprace™ can maintain process tube temperatures up to 250°F (121.1°C), depending upon ambient conditions.

Heating Cables

Cables are available in 120V and 208-277 volt, with Heat outputs of 5, 10, 15 and 20 watt/ft.

SH-Temprace™ is rated per NEC standards. Cables with heat outputs of 3, 5 and 8 watts/ft have a T3 rating. Cables with heat outputs of 10, 15 and 20 watts/ft have a T2D rating.

Parflex standard SH designs come with an internal tinned copper braid on the heating cable for grounding purposes and a Fluoropolymer jacket over the heating cable to provide additional protection against many harsh environments.

Common Tube Materials and Sizes

Temprace™ is readily available in 1/4", 3/8" and 1/2" sizes as well as metric sizes. (6 mm, 8mm, 10mm and 12mm) The most common stock alloys are Seamless Copper Type #122 DHP ASTM B68-B75, as well as, seamless and welded stainless steel tubing Type 316/316L ASTM A269. Many other alloys, ASTM standards and sizes are available upon request. (See *Technical Data* Section)

Testing

All Temprace™ products are pressure tested prior to shipment. Third party testing and witnessing is available upon request, including DNV, ABS and Lloyd's Register. Contact factory for complete details.

Jacketing Materials

Black, UV-resistant, FR-PVC is our standard material; however, other jacketing materials are available upon request, including non-halogenated FR-TPE and Urethanes. (See *Technical Data* Section)

NOTE: It is absolutely necessary to seal the ends against contamination from moisture and/or corrosive liquids. Parker Hannifin cannot assume any liability for product damage caused by moisture from unsealed ends.



WARNING

This product can expose you to chemicals including Antimony Oxide (Antimony Trioxide), which is known to the State of California to cause cancer. For more information go to www.P65Warnings.ca.gov.

How to Specify & Order

SH- Self-Regulating High Temperature Maintenance Electric Trace Bundles: MTR = 400°F (204°C)

Maintain Temperatures up to 250°F (121°C) with a *Maximum Internal Exposure up to 400°F (204°C)

SH - 5 1 2 - B 08 35 B - V B

SH	5	1	2
Bundle Type	Heating Cable (Watts/ft)	Heating Cable Voltage	Area Classification
SH= Self-Regulating High Temperature	See Selection Chart 3 = 3 watt 5 = 5 watt 8 = 8 watt 1 = 10 watt A = 15 watt D = 20 watt	1 = 120V 2 = 240V * 240 volt cables can be powered at 208, 240 or 277 volts	1 = Class 1, Div. 1 Areas 2 = General Purpose & Class I, Div.2 Areas







B	08	35	B	V	B
Process Tube Material	Process Tube Size	Process Tube Size	Number of Process Tubes	Jacket Material	Jacket Color
1= Smls Copper Type DHP Alloy No 122. ASTM B68/B75 2= Welded Stainless Steel Type 316/316L ASTM A269 3= Welded Stainless Steel Type 304 ASTM A269 B= Smls 316/316L ASTM A269 C= Smls 304 ASTM A269 D= Smls Monel Type 400 E= Smls Hastelloy C22 H= Smls 316H ASTM A213 I= Smls Incoloy 825 L= Electropolish Smls 316/316L ASTM A269 (10Ra Max) M=Smls 316/316L ASTM A213 S= Silco Smls 316/316L Stainless ASTM A269 P= PFA Fluoropolymer F= FEP Fluoropolymer T= TFE Fluoropolymer 7= Parflex 919 PTFE SS Braided Hose 9= Customer Specified Tube Material	O.D. See Charts Imperial 02=1/8" 03=3/16" 04=1/4" 05=5/16" 06=3/8" 07=7/16" 08=1/2" 10=5/8" 12=3/4" 16=1" Metric MA=2mm MB=4mm MC=6mm MD=8mm ME=10mm MF=12mm MG=14mm MH=16mm	Wall Thickness See Charts Imperial 16=.016" 20=.020" 28=.028" 30=.030" 31=.031" 32=.032" 35=.035" 40=.040" 47=.047" 49=.049" 50=.050" 62=.062" 65=.065" 83=.083" Metric 89=.89mm 10=1.0mm 15=1.5mm 20=2.0mm 25=2.5mm	A= 1 Tube B= 2 Tubes C= 3 Tubes etc. P = 2 Tube Parallel Design	V=FR-PVC T=FR-TPE U=FR-PUR P=PUR R=TPR E=FRPE L=LDPE F=PVDF Note: Parflex standard jacket material is FR-PVC	N=Black B=Blue G=Green O=Orange Y=Yellow P=Purple R=Red W=White Note: Parflex standard color jacket is black Note: For standard black FR-PVC jacketed products -VN may be dropped

*Maximum Temperatures are Subject to Ambient Conditions (See Heater Selection Chart)



WARNING

This product can expose you to chemicals including Antimony Oxide (Antimony Trioxide), which is known to the State of California to cause cancer. For more information go to www.P65Warnings.ca.gov.

Part Number #	Process Tube O.D. (in.)	Wall Thickness (in.)	Nominal Product O.D. (in.)	Product Weight (lbs./ft.)	Minimum Bend Radius (in.)	Watt Density per foot / Voltage**	Circuit Length Ft @ 50°F Start-up / Breaker (amps)	Performance At Various Ambient Conditions	
						Watt/Ft		At -40°F (-40°C) will maintain at least***	At 80°F (23.9°C) will maintain at least***
SH- Single Process Tube - Seamless Stainless Tubing* - Maximum Internal Exposure Temperature, Power off 400°F (204°C)									
SH512-B0435A	1/4	0.035	1.21	0.33	7	5 watt / 120V	360ft / 30A	40°F (4°C)	145°F (63°C)
SH512-B0635A	3/8	0.035	1.31	0.39	8	5 watt / 120V	360ft / 30A	40°F (4°C)	140°F (60°C)
SH512-B0835A	1/2	0.035	1.41	0.46	8	5 watt / 120V	360ft / 30A	40°F (4°C)	135°F (57°C)
SH812-B1249A	3/4	0.049	1.64	0.68	10	8 watt / 120V	285ft / 30A	40°F (4°C)	150°F (65°C)
SH- Dual Process Tube - Seamless Stainless Tubing* - Maximum Internal Exposure Temperature, Power off 400°F (204°C)									
SH512-B0435B	(2) 1/4	0.035	1.28	0.42	8	5 watt / 120V	360ft / 30A	40°F (4°C)	145°F (63°C)
SH512-B0635B	(2) 3/8	0.035	1.43	0.54	9	5 watt / 120V	360ft / 30A	40°F (4°C)	135°F (57°C)
SH812-B0835B	(2) 1/2	0.035	1.61	0.66	10	8 watt / 120V	285ft / 30A	40°F (4°C)	150°F (65°C)
SH812-B1239B	(2) 3/4	0.049	1.99	1.11	12	8 watt / 120V	285ft / 30A	40°F (4°C)	140°F (60°C)

*Many other alloys available, as well as seamless stainless steel tubing.

**Product is also available in 208, 240 and 277V

*** In some cases, without use of a controller, this design could maintain higher temperatures at the ambient temperature shown. The temperature maintained is based upon the watt density heater shown. Higher watt density heaters could be used to achieve a greater maintenance temperatures.

FM – Factory Mutual

General Purpose - Ordinary Locations
Hazardous Locations, when installed with Parflex accessories.

- Class I, Div. 2, Groups B, C and D (gases, vapors)
- Class II, Div.2, Group F, G (Combustible dust)
- Class III, Div.2, (Ignitable fibers and filings)

T-Temperature Ratings

- 3, 5 and 8 watt rated T3 temperature class
- 10, 15 and 20 watt rated T2D temperature class

CSA – Canadian Standards Association

CSA Certified for ordinary locations
for certified hazardous locations contact Parflex

ATEX - Certified Cables & accessories available

Electrical Specifications:

Operating Voltage: 120 V or 240V
Bus Wire Voltage Rating: 600 Volts
Bus Wire Size: 16 AWG

Maximum Circuit Length (ft) at Start-up °F

High-Temp Cable Rating	50°F (10°C) Circuit Length In Feet				0°F (-18°C) Circuit Length In Feet				-20°F (-29°C) Circuit Length In Feet			
	15	20	30	40	15	20	30	40	15	20	30	40
Circuit Breaker Size (Amps)	15	20	30	40	15	20	30	40	15	20	30	40
5 watt / 120V	180	240	360	375	165	220	330	375	155	210	310	375
5 watt / 240V	360	480	720	750	325	430	645	750	310	415	620	750
10 watt / 120V	95	125	190	250	90	110	175	250	85	100	170	245
10 watt / 240V	190	255	385	490	165	225	345	490	155	215	330	470
15 watt / 120V	70	95	145	190	65	85	125	165	60	80	120	150
15 watt / 240V	145	190	290	385	120	175	270	360	115	165	260	340
20 watt / 120V	60	75	115	155	50	65	105	140	45	65	100	135
20 watt / 240V	115	155	230	305	100	135	200	270	90	130	195	255



WARNING

This product can expose you to chemicals including Antimony Oxide (Antimony Trioxide), which is known to the State of California to cause cancer. For more information go to www.P65Warnings.ca.gov.

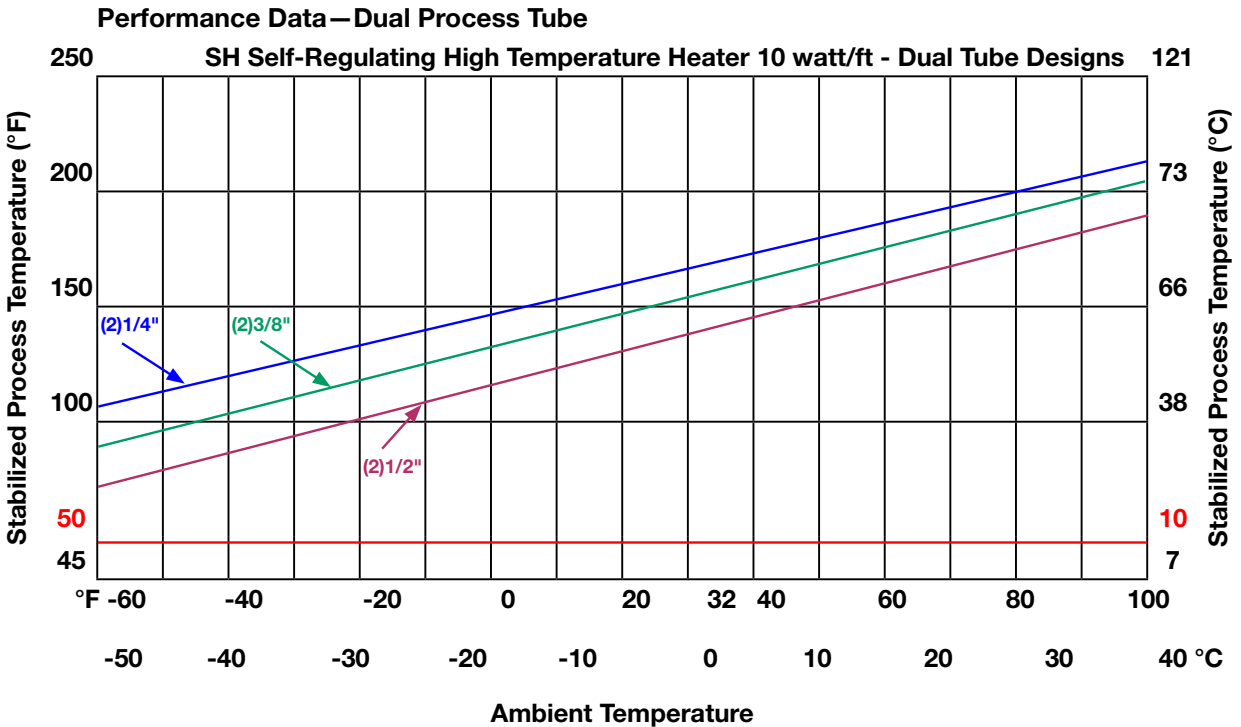
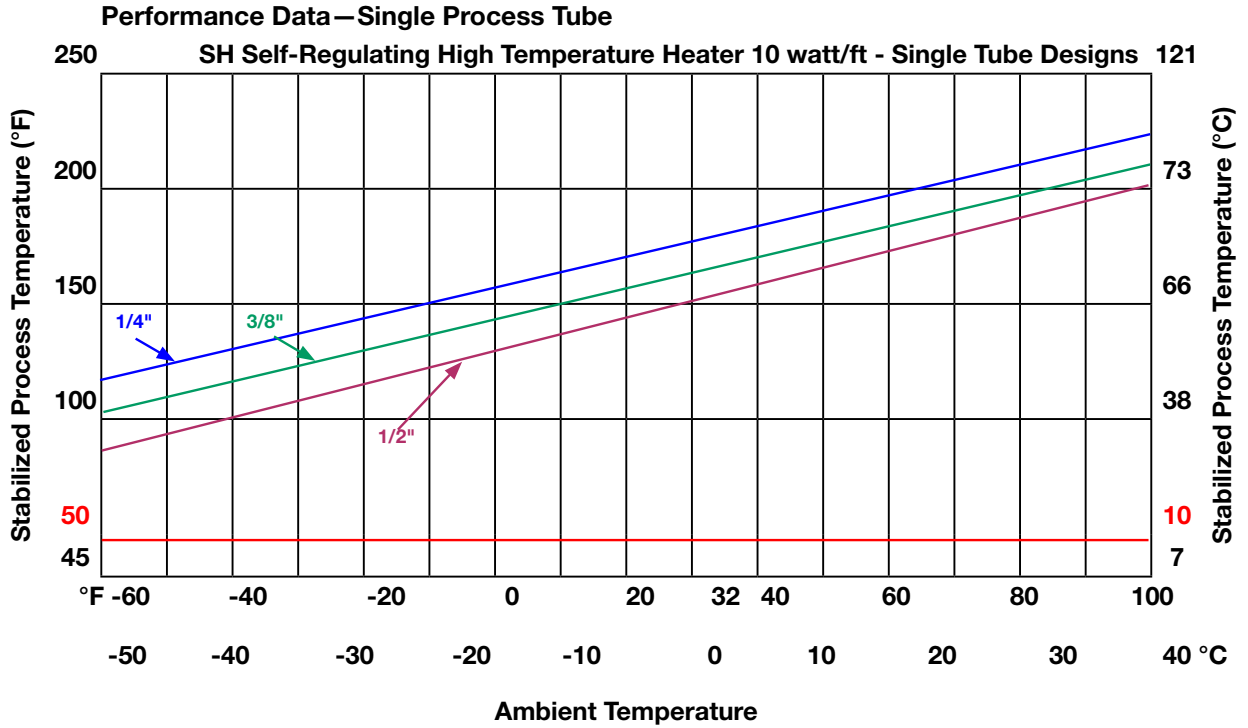

SH Series Self-Regulating Bundles Maximum Exposure 400°F (204°C) Process Tubes 1/4" to 1/2" O.D. (6mm to 12mm) Single or Dual Tube Designs					
Minimum Process Temperature to Maintain**	Standard Insulation Package*				
	Environments Average High / Low Ambient Conditions				
	Extreme Cold	Cold	Moderate Cold	Moderate	Warm
	-65°F Low 80°F High	-40°F Low 80°F High	-10°F Low 95°F High	0°F Low 105°F High	10°F Low 115°F High
120 Volts	-54°C Low 26°C High	-40°C Low 26°C High	-24°C Low 35°C High	-18°C Low 40°C High	-13°C Low 46°C High
40°F (4°C)	8 Watt / Ft	8 Watt / Ft	5 Watt / Ft	3 Watt / Ft	3 Watt / Ft
50°F (10°C)	10 Watt / Ft	8 Watt / Ft	5 Watt / Ft	5 Watt / Ft	5 Watt / Ft
75°F (24°C)	15 Watt / Ft	10 Watt / Ft	8 Watt / Ft	8 Watt / Ft	8 Watt / Ft
100°F (38°C)	15 Watt / Ft	15 Watt / Ft	10 Watt / Ft	10 Watt / Ft	10 Watt / Ft
125°F (52°C)	20 Watt / Ft	20 Watt / Ft	15 Watt / Ft	15 Watt / Ft	15 Watt / Ft
150°F (66°C)			20 Watt / Ft	20 Watt / Ft	20 Watt / Ft
175°F (79°C)					20 Watt / Ft
208 Volts					
40°F (4°C)	10 Watt / Ft	8 Watt / Ft	5 Watt / Ft	5 Watt / Ft	3 Watt / Ft
50°F (10°C)	15 Watt / Ft	10 Watt / Ft	8 Watt / Ft	5 Watt / Ft	5 Watt / Ft
75°F (24°C)	15 Watt / Ft	15 Watt / Ft	10 Watt / Ft	8 Watt / Ft	8 Watt / Ft
100°F (38°C)	20 Watt / Ft	20 Watt / Ft	15 Watt / Ft	10 Watt / Ft	10 Watt / Ft
125°F (52°C)		20 Watt / Ft	20 Watt / Ft	15 Watt / Ft	15 Watt / Ft
150°F (66°C)				20 Watt / Ft	20 Watt / Ft
175°F (79°C)					20 Watt / Ft
240 Volts					
40°F (4°C)	8 Watt / Ft	8 Watt / Ft	5 Watt / Ft	3 Watt / Ft	3 Watt / Ft
50°F (10°C)	10 Watt / Ft	8 Watt / Ft	5 Watt / Ft	5 Watt / Ft	5 Watt / Ft
75°F (24°C)	15 Watt / Ft	10 Watt / Ft	8 Watt / Ft	8 Watt / Ft	8 Watt / Ft
100°F (38°C)	15 Watt / Ft	15 Watt / Ft	10 Watt / Ft	10 Watt / Ft	10 Watt / Ft
125°F (52°C)	20 Watt / Ft	20 Watt / Ft	15 Watt / Ft	15 Watt / Ft	15 Watt / Ft
150°F (66°C)			20 Watt / Ft	20 Watt / Ft	20 Watt / Ft
175°F (79°C)					20 Watt / Ft

*The above heater cable selection is based upon our standard insulation package. Other insulation packages are available to maintain higher temperatures.

**The maintenance temperature could actually be higher depending upon the size and number of tubes required. It is recommended that for precise temperature control a thermal sensor be used. Contact the factory for more exact product thermal properties based upon your application conditions.

How to Use:

- 1) Check to be sure you are using the correct chart.
- 2) Choose your operating voltage.
- 3) Choose the minimum process temperature you want to maintain. Note: If temperature is not shown, pick the next higher option.
- 4) Follow chart across to the ambient Condition that best match your area.
- 5) Use the watt-density shown for your part number derivation.

Note:

The watt-density selected will maintain the temperature indicated at a minimum. Depending upon actual ambient fluctuations, process tubes size and number of tubes, the maintenance temperature could be higher.

SH Series Self-Regulating Bundles
Maximum Exposure 400°F (204°C)
Process Tubes 3/4" to 1" O.D. (19mm to 25mm)
Single Tube Designs (Contact Factory for Multiple Tubes)

Minimum Process Temperature to Maintain**	Standard Insulation Package*				
	Environments Average High / Low Ambient Conditions				
	Extreme Cold	Cold	Moderate Cold	Moderate	Warm
	-65°F Low 80°F High	-40°F Low 80°F High	-10°F Low 95°F High	0°F Low 105°F High	10°F Low 115°F High
120 Volts	-54°C Low 26°C High	-40°C Low 26°C High	-24°C Low 35°C High	-18°C Low 40°C High	-13°C Low 46°C High
40°F (4°C)	10 Watt / Ft	8 Watt / Ft	5 Watt / Ft	5 Watt / Ft	3 Watt / Ft
50°F (10°C)	15 Watt / Ft	10 Watt / Ft	8 Watt / Ft	5 Watt / Ft	5 Watt / Ft
75°F (24°C)	15 Watt / Ft	15 Watt / Ft	10 Watt / Ft	8 Watt / Ft	8 Watt / Ft
100°F (38°C)	20 Watt / Ft	15 Watt / Ft	15 Watt / Ft	15 Watt / Ft	10 Watt / Ft
125°F (52°C)		20 Watt / Ft	20 Watt / Ft	15 Watt / Ft	15 Watt / Ft
150°F (66°C)				20 Watt / Ft	20 Watt / Ft
208 Volts					
40°F (4°C)	15 Watt / Ft	10 Watt / Ft	8 Watt / Ft	5 Watt / Ft	5 Watt / Ft
50°F (10°C)	15 Watt / Ft	10 Watt / Ft	8 Watt / Ft	8 Watt / Ft	5 Watt / Ft
75°F (24°C)	20 Watt / Ft	15 Watt / Ft	15 Watt / Ft	10 Watt / Ft	10 Watt / Ft
100°F (38°C)		20 Watt / Ft	15 Watt / Ft	15 Watt / Ft	15 Watt / Ft
125°F (52°C)			20 Watt / Ft	20 Watt / Ft	20 Watt / Ft
240 Volts					
40°F (4°C)	10 Watt / Ft	8 Watt / Ft	5 Watt / Ft	5 Watt / Ft	3 Watt / Ft
50°F (10°C)	15 Watt / Ft	10 Watt / Ft	8 Watt / Ft	5 Watt / Ft	5 Watt / Ft
75°F (24°C)	15 Watt / Ft	15 Watt / Ft	10 Watt / Ft	8 Watt / Ft	8 Watt / Ft
100°F (38°C)	20 Watt / Ft	15 Watt / Ft	15 Watt / Ft	15 Watt / Ft	10 Watt / Ft
125°F (52°C)		20 Watt / Ft	20 Watt / Ft	15 Watt / Ft	15 Watt / Ft
150°F (66°C)				20 Watt / Ft	20 Watt / Ft

*The above heater cable selection is based upon our standard insulation package. Other insulation packages are available to maintain higher temperatures.

** The maintenance temperature could actually be higher depending upon the size and number of tubes required. It is recommended that for precise temperature control a thermal sensor be used. Contact the factory for more exact product thermal properties based upon your application conditions.

How to Use:

- 1) Check to be sure you are using the correct chart.
- 2) Choose your operating voltage.
- 3) Choose the minimum process temperature you want to maintain. Note: If temperature is not shown, pick the next higher option.
- 4) Follow chart across to the ambient Condition that best match your area.
- 5) Use the watt-density shown for your part number derivation.

Note:

The watt-density selected will maintain the temperature indicated at a minimum. Depending upon actual ambient fluctuations, process tubes size and number of tubes, the maintenance temperature could be higher.

4041-2101 Temptrace™ Power Connection Kit with Junction Box

4041-2101 Temptrace™ Electric Power Connection Kit for SL and SH Series Self-Regulating Bundles



The Temptrace™ Power Connection Kit with Junction Box can be used to make an easily installed combination power connection and waterproof seals for single and double tube bundles.

Power Connection Kit Contains:

- 1 Molded junction box consisting of : Base - Box - Lid - Hardware
- 4 Heater grommets (grommet used based upon heater type)
- 1 Pipe strap 1" – 3-1/2"
- 1 RTV-103BLK
- 1 Three position terminal block
- 1 Mounting screw for terminal block
- 1 Caution label

Caution: The heater will come in contact with the power feed wires in the junction box. Make sure that the temperature rating of the power feed wire insulation is adequate for the heater used.

Ground Fault Equipment Protection Devices (GFEPDs):

The IEEE standard (515-1989) for heating cables requires the use of GFEPDs with a nominal 30 milliampere trip level for "piping systems in classified areas, those areas requiring a high degree of maintenance, or which may be exposed to physical abuse or corrosive atmospheres."

Approvals:

FM – Factory Mutual Approved
Ordinary Locations
UL Listed
Hazardous (Classified) Locations

Class I, Division 2, Groups B, C and D
Class II, Division 2, Groups F and G
Class III, Division 2

CSA Certified for use in ordinary areas

ATEX Approved Kits Available



WARNING

This product can expose you to chemicals including Antimony Oxide (Antimony Trioxide), which is known to the State of California to cause cancer, and Ethylene Oxide, which is known to the State of California to cause birth defects or other reproductive harm. For more information go to www.P65Warnings.ca.gov.

4041-5300 Temptrace™ Universal Kit for Self-Regulating Bundles

4041-5300 Temptrace™ Electric Splice or Tee Connection Kit for SL and SH Series Self-Regulating Bundles

Kit can be used to create an easily installed combination power splice and tee for self-regulating bundles. The kit contains enough components to make one input power connection or one input power splice connection or one splice/tee connection, as well as, two end terminations. It also includes RTV for bundle end seal.



Connection Kit Contains:

- | | |
|---|--------------------------|
| (1) 3/4" Pipe Stand | (3) Ring Terminals |
| (1) Sealing Grommet | (2) Cable Entry Fittings |
| (4) Stainless Steel Pipe Straps
(2-large, 2-small) | (1) 3/4" Pipe Plug |
| (1) 3 Hub Box | (1) Grounding Screw |
| (1) Box Cover | (2) RTV-103BLK |
| (6) Wire Nuts | (1) SS Label |
| (2) Butt Splice Connectors | (2) Reducing Bushings |
| (1) SK-612 (Seal Patch Kit) | (3) 1" Heat Shrink Tubes |
| | (3) 3" Heat Shrink Tubes |

Caution: The heater will come in contact with the power feed wires in the junction box. Make sure that the temperature rating of the power feed wire insulation is adequate for the heater used.

Ground Fault Equipment Protection Devices (GFEPDs):

The IEEE standard (515-1989) for heating cables requires the use of GFEPDs with a nominal 30 milliampere trip level for "piping systems in classified areas, those areas requiring a high degree of maintenance, or which may be exposed to physical abuse or corrosive atmospheres."



WARNING

This product can expose you to chemicals including Antimony Oxide (Antimony Trioxide), which is known to the State of California to cause cancer, and Ethylene Oxide, which is known to the State of California to cause birth defects or other reproductive harm. For more information go to www.P65Warnings.ca.gov.

4041-6101 Electrical End Termination Kit for Self-Regulating Bundles

Parflex Multitube® electrical end termination kits are designed to provide a method of terminating the non-powered end of the heating cable in Self-Regulating Temptrace™ bundles.

4041-6101 for use with Single Tube Bundle

Kit includes:

- (1) HSB-1 (single-leg heat shrink boot)
- (1) ESHS-1 (1" adhesive-lined, semi-rigid polyolefin tube)
- (1) ESHS-3 (3" adhesive-lined, semi-rigid polyolefin tube)

4041-6102 for use with Two Tube Bundle

Kit includes:

- (1) HSB-2 (two legged heat shrink boot)
- (1) ESHS-1 (1" adhesive-lined, semi-rigid polyolefin tube)
- (1) ESHS-3 (3" adhesive-lined, semi-rigid polyolefin tube)



4041-8200 Electrical End Termination Kit for SL and SH Self-Regulating Bundles

Parflex Multitube® electrical end termination kits are designed to provide a method of terminating the non-powered end of the heating cable in Self-Regulating Temptrace™ bundles.

Also in kit but not shown:

- (1) Two-part mounting block
- (1) Silicone end cap
- (2) Screws
- (1) Caution label
- (1) Roll glass tape
- (3) Additional heat grommets



Approvals:

FM – Factory Mutual Approved
Ordinary Locations
UL Listed
Hazardous (Classified) Locations

Class I, Division 2, Groups B, C and D
Class II, Division 2, Groups F and G
Class III, Division 2

CSA Certified for use in ordinary areas and:
Class I, Division 2, Groups A, B, C and D
Class II, Division 2, Groups F and G



WARNING

This product can expose you to chemicals including Antimony Oxide (Antimony Trioxide), which is known to the State of California to cause cancer, and Ethylene Oxide, which is known to the State of California to cause birth defects or other reproductive harm. For more information go to www.P65Warnings.ca.gov.

Thermostats/Temperature Controllers

Thermostats are used to monitor the temperature of the process tubes or monitor the ambient temperature. Each thermostat is a mechanically actuated on/off temperature switch that controls the power to an electric tracer to achieve the desired process tube temperature. The high and low temperatures are pre-set at the factory, but are field-adjustable.

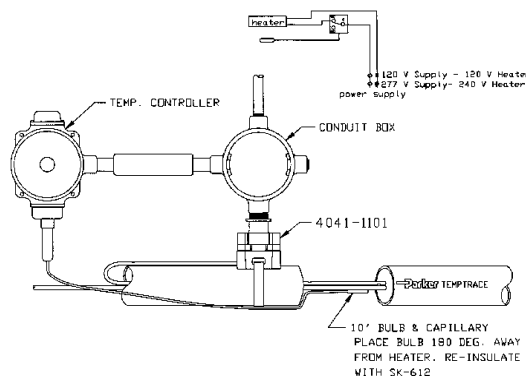

4012-01145 NEMA 4 Thermostat/ Temperature Controller



Specifications:

TemperatureField Adjustable, Tamper proof +25 to +325°F (-3 to +162°C)
 Switch.....125/250/480 VAC – 22 amp SPDT Snap Acting
 Accuracy ±1% of full scale, approximately 3°F (1.6°C)
 Capillary.....a10 Ft. type 304 S.S.
 Bulb1/8" O.D. x 5/8" long type 304 S.S.
 Size..... NEMA 4 x 4-1/4"H x 3-7/16W x 3-3/16D

Note: For further information and callout references, contact the Division.

4012-05145 NEMA 4x Thermostat/ Temperature Controller



Specifications:

Temperature Field Adjustable, Tamper proof -125 to +500°F (-85 to +265°C)
 Switch.....120/240 VAC – 20 amp SPDT Snap Acting
 Accuracy ±1% of full scale, approximately 3°F (1.6°C)
 Capillary.....6 Ft. type 304 S.S.
 Bulb3/8" O.D. x 2-1/4" long type 304 S.S.
 Size..... NEMA 4 x 4-1/4"H x 3-7/16W x 3-3/16D

Note: For further information and callout references, contact the Division.

4012-01147 NEMA 7 Thermostat/ Temperature Controller



Specifications:

TemperatureField Adjustable, Tamper proof +25 to 325°F (-3 to +162°C)
 Switch.....125/250/480 VAC – 22 amp SPDT Snap Acting
 Accuracy ±1% of full scale, approximately 3°F (1.6°C)
 Capillary.....10 Ft. type 304 S.S.
 Bulb1/8" O.D. x 5/8" long type 304 S.S.
 Size..... NEMA 7 5-1/16H x 5-1/8W x 5-1/4D

Note: For further information and callout references, contact the Division.

4012-06105 NEMA 4x Thermostat/ Temperature Controller



Specifications:

TemperatureField Adjustable, Tamper proof +15 to +140°F (-9 to +60°C)
 Switch.....125/250/480 VAC – 22 amp SPDT Snap Acting
 Accuracy ±1% of full scale, approximately 3°F (1.6°C)
 Bulb Fluid filled stem
 NEMA Rating.....NEMA 4 x

Note: For further information and callout references, contact the Division.



WARNING

This product can expose you to chemicals including Lead, which is known to the State of California to cause cancer and birth defects or other reproductive harm. For more information go to www.P65Warnings.ca.gov.

Parker Temptrace™ Feed Through (PTFT) Kit

Parflex PTFT kits provide a water tight seal where the heat trace tubing bundle enters into a junction box or instrument enclosure.

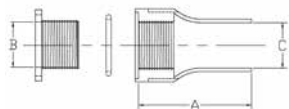

Molded Feed Through Part Number	Bundle O.D. Min-Max	"A" Length Nominal	Cabinet Wall Thickness Max	Drill Hole Size	"B" Feed Through I.D.	"C" Minimum Expanded I.D.
PTFT 1.50	0.75 - 1.50" (19 - 38 mm)	4.5" (11.4 cm)	0.375" (9.5 mm)	2" (5.1 cm)	1.60" (4.1 cm)	1.70" (4.3 cm)
PTFT 2.00	0.75 - 2.0" (19 - 51 mm)	7.0" (17.8 cm)	0.375" (9.5 mm)	2.36" (6.0 cm)	2.10" (5.1 cm)	2.75" (7.0 cm)
PTFT 2.75	1.43 - 2.75" (19 - 70 mm)	7.0" (17.8 cm)	1.0" (25.4 mm)	3.50" (8.9 cm)	2.75" (7.0 cm)	2.75" (7.0 cm)

PVC Pipe Fitting Style Part Number	"C" Bundle O.D. Min-Max	"A" Length Nominal	Cabinet Wall Thickness Max	Drill Hole Size	"B" Feed Through I.D.
PTFT 3.25	1.50 - 3.25" (38 - 83 mm)	10" (25.4 cm)	1.125" (28.6 mm)	4.50" (11.4 cm)	3.50" (8.9 cm)
PTFT 4.50	2.00 - 4.50" (51 - 114 mm)	10" (25.4 cm)	1.25" (28.6 mm)	5.00" (12.0 cm)	4.50" (11.4 cm)
PTFT 5.0	2.00 - 5.00" (51 - 114 mm)	12" (30.5 cm)	1.125" (28.6 mm)	5.50" (13.2 cm)	5.00" (12.0 cm)



Heat Shrinkable Boots (HSBs)

Parflex heat shrink boots (HSB) are designed to prevent moisture from entering the ends of Parflex Temptrace™ bundles. The dash number represents the number of breakouts in each boot. The boots can be used on 1/4", 3/8", or 1/2" tubes, or as a seal for the heating cable



HSB-1



HSB-2

Part Number	Before Heat Shrinking		After Heat Shrinking					
	Body I.D.	Leg(s) I.D.	Body			Leg(s)		
			I.D.	Thick	Length	I.D.*	Thick	Length
HSB-1	1.50	-	0.23	0.16	6.00	No Legs		
HSB-2	3.40	1.50	0.90	0.16	3.00	0.30	0.12	1.20
HSB-3	2.40	1.00	0.90	0.16	2.30	0.30	0.12	1.20
HSB-4	2.30	1.00	0.98	0.16	3.00	0.28	0.12	1.20
HSB-5	3.70	1.40	1.27	0.16	4.70	0.58	0.12	2.00
HSB-6	5.20	2.00	1.75	0.16	6.00	0.60	0.12	2.00

Grommet Selection Chart	
Part Number	Tube Size O.D. (inches)
GESKO-2	1/8
GESKO-4	1/4
GESKO-6	3/8
GESKO-8	1/2

*Where "After Shrinking" Leg I.D. is larger than the tube size in the bundle, a silicone grommet or RTV should be used in conjunction with the boot to ensure a complete seal. (See grommet selection list to the right or RTV data listed on pg 14.)



WARNING

This product can expose you to chemicals including Antimony Oxide (Antimony Trioxide), which is known to the State of California to cause cancer, and Ethylene Oxide, which is known to the State of California to cause birth defects or other reproductive harm. For more information go to www.P65Warnings.ca.gov.

Parker Electric Trace Design Criteria Quote Request

Fax Inquiry To: Sales Office
330-296-6747

Date: _____ Customer Name: _____

Bundle Type: SL-Temprace™ Low Temperature Maintenance up to 150°F (65°C) and Freeze Protection and maximum internal exposure of 185°F power off.)

SH Temprace™ (High Temperature Maintenance up to 250° F (121° C) and maximum internal exposure of 400°F power off.)

Total Quantity: _____ Feet
Meters

Specified Lengths: _____

Part Number: _____ (See How-to-Order in applicable product section.)

If not sure of part number, complete the following criteria:

Maximum Temperature to be maintained: _____

Lowest ambient temperature: _____

Highest ambient temperature: _____

What is the highest internal process tube or steam purge temperature? _____

Process Tubes:

How many process tubes: _____

Size: (O.D. and wall thickness): _____ Inches
mm

Tube Material: _____

Trace Tube:

Size: (O.D. and wall thickness): _____ Inches
mm

Tube Material: _____

Outer Jacket Type: (Note: Black FR-PVC is Standard)

- | | |
|---------------------------------|--------------------------------------|
| FR-PVC <input type="checkbox"/> | TPR <input type="checkbox"/> |
| FR-TPE <input type="checkbox"/> | FRPE <input type="checkbox"/> |
| FR-PUR <input type="checkbox"/> | LDPE <input type="checkbox"/> |
| PUR <input type="checkbox"/> | PVDF <input type="checkbox"/> |

Area Classification

- | | |
|---------------------|--------------------------|
| General Purpose | <input type="checkbox"/> |
| Class 1, Division 2 | <input type="checkbox"/> |
| Class 1, Division 1 | <input type="checkbox"/> |

Approval Agency

- | | | |
|--------------------------|--------------------------|--------------------------|
| FM | CSA | ATEX |
| <input type="checkbox"/> | <input type="checkbox"/> | <input type="checkbox"/> |



WARNING

This product can expose you to chemicals including Antimony Oxide (Antimony Trioxide), which is known to the State of California to cause cancer. For more information go to www.P65Warnings.ca.gov.

Section 2 —

IS – Intermittent Steam Purge Bundles for Freeze Protection

Freeze Protection Bundles Designed for **Intermittent*** High-Temperature Steam Purge



General Design

Parflex IS-Intermittent Steam purge bundles are thermally insulated with a composite layer of fiberglass that allows for occasional, high-temperature steam purge up to 1100°F (593°C) while ensuring freeze protection during winter through the use of self-regulating heating cables.

Parflex IS-Intermittent Steam purge bundles are properly insulated to ensure that the outer surface area of the bundle remains at or below 140°F (60°C) during steam purge conditions at the highest specified ambient temperature, meeting NEC Personnel Protection Code 427.12

IS- Intermittent Steam purge bundles are designed to provide a freeze protection temperature of 40°F (4.4°C) at the lowest specified ambient temperature.

Parflex IS-Intermittent Steam products are readily available in single and double tube designs. The most common tube sizes requested are 3/8" and 1/2" Seamless Stainless Steel 316/316L/316H alloys in either an average wall specification, ASTM A269, or minimum wall specification, ASTM A213. Other alloys and standards are available.

We also have many other sizes available; including metric sizes 6 mm, 8mm, 10mm and 12mm. (See How to Specify & Order for details.)

Testing

All IS-Intermittent Steam products are pressure tested prior to shipment. Third party testing and witnessing is available upon request, including DNV, ABS and Lloyd's Register. Contact factory for complete details.

Jacketing Materials

Black, UV-resistant FR-PVC is our standard material; however, other jacketing materials are available upon request, including non-halogenated FR-TPE and Urethanes. Colored jackets are also available upon request. (See How to Specify and Order for details.)

Heating Cables

Cables are available in 120V and 208-277 volt, with Heat outputs of 5, 10, 15 and 20 watt/ft.

Parflex standard IS designs come with an internal tinned copper braid on the heating cable for grounding purposes and a Fluoropolymer jacket over the heater to provide additional protection against harsh environments.

*Intermittent Design

Bundles can be steam purged for a period of 5 minutes once a day. During steam purge, the outer jacket surface temperature will not exceed 140°F (60°C).



WARNING

This product can expose you to chemicals including Antimony Oxide (Antimony Trioxide), which is known to the State of California to cause cancer. For more information go to www.P65Warnings.ca.gov.

How To Specify & Order

IS-Intermittent Steam Purge Bundles

Freeze Protection Bundles Designed For **Intermittent** High-Temperature Steam Purge

IS - B 08 49 B - 5 1 2 C - V 4 B







IS Product Family	B Process Tube Material	08 Process Tube Size	49 Process Tube Size	B Number of Process Tubes	5 Maximum Steam Purge Temperature
<p>IS= Intermittent High Temperature Steam</p> <p>** Intermittent is defined as steam purge for 5 minutes or less</p>	<p>1= Smls Copper Type DHP Alloy No 122. ASTM B68-B75</p> <p>2= Welded Stainless Steel Type 316/316L ASTM A269</p> <p>3= Welded Stainless Steel Type 304 ASTM A269</p> <p>B= Smls 316/316L ASTM A269</p> <p>C= Smls 304 ASTM A269</p> <p>D= Smls Monel Type 400</p> <p>E= Smls Hastelloy C22</p> <p>H= Smls 316H ASTM A213</p> <p>I = Smls Incoloy 825</p> <p>L= Electropolish Smls 316/316L ASTM A269 (10Ra Max)</p> <p>M=Smls 316/316L ASTM A213</p> <p>S= Silco Smls 316/316L ASTM A269</p> <p>P= PFA Fluoropolymer</p> <p>F= FEP Fluoropolymer</p> <p>T= TFE Fluoropolymer</p> <p>7= Parflex 919 PTFE SS Braided Hose</p> <p>9= Customer Specified Tube Material</p>	<p>O.D.</p> <p>See Selection Charts</p> <p>Imperial</p> <p>02=1/8" 03=3/16" 04=1/4" 05=5/16" 06=3/8" 07=7/16" 08=1/2" 10=5/8" 12=3/4" 16=1"</p> <p>Metric</p> <p>MA=2mm MB=4mm MC=6mm MD=8mm ME=10mm MF=12mm MG=14mm MH=16mm</p>	<p>Wall Thickness</p> <p>See Selection Charts</p> <p>Imperial</p> <p>16=.016" 20=.020" 28=.028" 30=.030 31=.031" 32=.032" 35=.035" 40=.040" 47=.047" 49=.049" 50=.050" 62=.062" 65=.065" 83=.083"</p> <p>Metric</p> <p>89=.89mm 10=1.0mm 15=1.5mm 20=2.0mm 25=2.5mm</p>	<p>Number of Process Tubes</p> <p>A= 1 Tube B= 2 Tubes C= 3 Tubes etc.</p> <p>P= 2 Tube Parallel Design</p>	<p>Maximum Steam Purge Temperature</p> <p>1= 1,000°F 5= 550°F (288°C) 6= 650°F (343°C) 7= 750°F (399°C) 8= 850°F (454°C) 9= other D= 1100°F (593°C)</p> <p>Note: For steam purges 400°F or less use Parker SL or SH Bundle Series. For temperatures above 1100°F contact factory.</p>

1 Heating Cable Voltage	2 Area Classification	C Average Environment Ambient Condition Range	V Jacket Material	4 *Maximum Jacket Surface Temperature Design	B Jacket Color
<p>1= 120VAC 2= 240VAC</p> <p>* 240 volt cables can be powered at 208, 240 or 277 volts</p>	<p>1= Class I, Division 1 Areas</p> <p>2= General Purpose/Class I, Division 2 Areas</p>	<p>Low/High</p> <p>A= -40°F/80°F B= -20°F/95°F C= 0°F/105°F D= 10°F/115°F</p>	<p>V = FR-PVC T = FR-TPE U = FR-PUR P = PUR R = TPR E = FRPE L = LDPE F = PVDF</p> <p>Note: Parflex standard jacket material is FR-PVC</p>	<p>4=140°F Jacket</p> <p>140°F meets NEC 427.12 for personnel protection</p>	<p>N=Black B=Blue G=Green O=Orange Y=Yellow P=Purple R=Red W=White</p> <p>Note: Parflex standard color jacket is black</p>



WARNING

This product can expose you to chemicals including Antimony Oxide (Antimony Trioxide), which is known to the State of California to cause cancer. For more information go to www.P65Warnings.ca.gov.

Part Number #	Process Tube O.D. (in.) 	Wall Thickness (in.) 	Nominal Product O.D. (in.) 	Product Weight (lbs./ft.) 	Min. Bend Radius (in.) 	Watt Density per foot / Voltage	Circuit Length Ft @ 50°F Start-up / Breaker (amps), 120V	Performance At Low Ambient Conditions	Maximum Allowable Intermittent Steam Purge	Maximum Jacket Surface Temperature during Steam Purge & High Ambient 80°F (26.6°C)
						Watt/FT	 @120V**	At -40°F (-40°C) will maintain at least freeze protection***	Intermittent is 5 minutes steam purge per day.	
IS- Single Process Tube - Seamless Stainless Steel*, ASTM A269										
IS-B0849A-612A-V4	(1) 1/2"	0.049"	1.93	0.59	12	10	250 Ft / 40 Amp	40°F (4.4°C)	650°F (343°C)	140°F (60°C)
IS-B0849A-712A-V4	(1) 1/2"	0.049"	2.01	0.61	12	10	250 Ft / 40 Amp	40°F (4.4°C)	750°F (399°C)	140°F (60°C)
IS-B0849A-812A-V4	(1) 1/2"	0.049"	2.09	0.62	13	15	190 Ft / 40 Amp	40°F (4.4°C)	850°F (454°C)	140°F (60°C)
IS-B0849A-912A-V4	(1) 1/2"	0.049"	2.09	0.62	13	15	190 Ft / 40 Amp	40°F (4.4°C)	950°F (510°C)	140°F (60°C)
IS- Dual Process Tube - Seamless Stainless Steel*, ASTM A269										
IS-B0849B-612A-V4	(2) 1/2"	0.049"	2.25	0.88	13	10	250 Ft / 40 Amp	40°F (4.4°C)	650°F (343°C)	140°F (60°C)
IS-B0849B-712A-V4	(2) 1/2"	0.049"	2.33	0.89	14	10	250 Ft / 40 Amp	40°F (4.4°C)	750°F (399°C)	140°F (60°C)
IS-B0849B-812A-V4	(2) 1/2"	0.049"	2.33	0.89	14	15	190 Ft / 40 Amp	40°F (4.4°C)	850°F (454°C)	140°F (60°C)
IS-B0849B-912A-V4	(2) 1/2"	0.049"	2.41	0.90	14	15	190 Ft / 40 Amp	40°F (4.4°C)	950°F (510°C)	140°F (60°C)

*Many other alloys available in addition to seamless stainless steel tubing.

**Product is also available in 208, 240 and 277V

***As ambient conditions go above -40°F (-40°C), without use of a controller, the product could maintain higher temperatures.



FM – Factory Mutual

General Purpose - Ordinary Locations
Hazardous Locations, when installed with Parflex accessories.

- Class I, Div. 2, Groups B, C and D (gases, vapors)
- Class II, Div.2, Group F, G (Combustible dust)
- Class III, Div.2, (ignitable fibers and filings)

T-Temperature Ratings

- 3, 5 and 8 watt rated T3 temperature class
- 10, 15 and 20 watt rated T2D temperature class

CSA – Canadian Standards Association

CSA Certified for ordinary locations
For certified hazardous locations contact Parflex

ATEX - Certified cables & accessories available

Electrical Specifications:

Operating Voltage: 120 V or 240V
Bus Wire Voltage Rating: 600 Volts
Bus Wire Size: 14 AWG



WARNING

This product can expose you to chemicals including Antimony Oxide (Antimony Trioxide), which is known to the State of California to cause cancer. For more information go to www.P65Warnings.ca.gov.

CS – Continuous Steam Purge Bundles for Freeze Protection

Freeze Protection Bundles Designed For **Continuous** High-Temperature Steam Purge Exposure



General Design

Parflex CS-Continuous Steam purge bundles are thermally insulated with a composite layer of fiberglass that allows for continuous, high-temperature steam purge up to 1100°F (593°C) while ensuring freeze protection during winter through the use of self-regulating heating cables.

Parflex CS-Continuous Steam purge bundles are properly insulated to meet customer specified jacket surface temperature requirements, during the highest steam purge conditions and maximum ambient temperature requested. (See How to Specify & Order for details.)

CS-Continuous Steam purge bundles are designed to provide a freeze protection temperature of 40°F (4.4°C) at the lowest specified ambient temperature.

Heating Cables

Cables are available in 120V and 208-277 volt, with heat outputs of 5, 10, 15 and 20 watt/ft.

Parflex standard CS designs come with an internal tinned copper braid on the heating cable for grounding purposes and a Fluoropolymer jacket over the heating cable to provide additional protection against many harsh environments.

Continuous Steam Purge

Internal bundle tubes can be steam purged for any duration required without effecting performance to the heating element. The outer jacket surface temperature can vary depending upon customer design specifications. (See How to Specify & Order for details.)



Common Tube Materials and Sizes

Parflex CS-Continuous Steam products are readily available in single and double tube designs. The most common tube sizes requested are 3/8" and 1/2" Seamless Stainless Steel 316/316L/316H alloys in either an average wall specification, ASTM A269, or minimum wall specification, ASTM A213. Other alloys and standards are available.

We also have available many other sizes; including metric sizes 6 mm, 8mm, 10mm and 12mm. (See How to Specify & Order for details.)

Testing

All CS-Intermittent Steam products are pressure tested prior to shipment. Third party testing and witnessing is available upon request, including DNV, ABS and Lloyd's Register. Contact factory for complete details.

Jacketing Materials

Black, UV-resistant FR-PVC is our standard material; however, other jacketing materials are available upon request, including non-halogenated FR-TPE and Urethanes. Colored jackets are also available upon request. (See How to Specify & Order for details.)



WARNING

This product can expose you to chemicals including Antimony Oxide (Antimony Trioxide), which is known to the State of California to cause cancer. For more information go to www.P65Warnings.ca.gov.

How to Specify & Order

CS-Continuous High Temperature Steam Purge Bundles

Freeze Protection Bundles Designed For **Continuous** High-Temperature Steam Purge Exposure

CS - B 08 49 B - 5 1 2 C - V 4 B







CS	Product Family	B	08	Process Tube Size	49	B	Number of Process Tubes	5	Maximum Steam Purge Temperature
	<p>CS= Continuous High Temperature Steam Purge</p>	<p>1= Smls Copper Type DHP Alloy No 122. ASTM B68-B75 2= Welded Stainless Steel Type 316/316L ASTM A269 3= Welded Stainless Steel Type 304 ASTM A269</p> <p>B= Smls 316/316L ASTM A269 C= Smls 304 ASTM A269 D= Smls Monei Type 400 E= Smls Hastelloy C22 H= Smls 316H ASTM A213 I= Smls Incoloy 825 L= Electropolish Smls 316/316L ASTM A269 (10Ra Max) M= Smls 316/316L ASTM A213 S= Silco Smls 316/316L ASTM A269 P= PFA Flouropolymer F= FEP Fluoropolymer T= TFE Fluoropolymer</p> <p>7= Parflex 919 PTFE SS Braided Hose 9= Customer Specified Tube Material</p>	<p>O.D.</p> <p>See Selection Charts</p> <p>Imperial</p> <p>02=1/8" 03=3/16" 04=1/4" 05=5/16" 06=3/8" 07=7/16" 08=1/2" 10=5/8" 12=3/4" 16=1"</p> <p>Metric</p> <p>MA=2mm MB=4mm MC=6mm MD=8mm ME=10mm MF=12mm MG=14mm MH=16mm</p>	<p>Wall Thickness</p> <p>See Selection Charts</p> <p>Imperial</p> <p>16=.016" 20=.020" 28=.028" 30=.030" 31=.031" 32=.032" 35=.035" 40=.040" 47=.047" 49=.049" 50=.050" 62=.062" 65=.065" 83=.083"</p> <p>Metric</p> <p>89=.89mm 10=1.0mm 15=1.5mm 20=2.0mm 25=2.5mm</p>	<p>A= 1Tube B= 2Tubes C= 3 Tubes etc.</p> <p>P= 2 Tube Parallel Design</p>			<p>1= 1,000°F 5= 550°F (288°C) 6= 650°F (343°C) 7= 750°F (399°C) 8= 850°F (454°C) 9= other D= 1100°F (593°C)</p> <p>Note: For steam purges 400°F or less use Parker SL or SH Bundle Series. For temperatures above 1100°F contact factory.</p>	

1	Heating Cable Voltage	2	Area Classification	C	Average Environment Ambient Condition Range	V	Jacket Material	4	Jacket Surface Temperature Design	B	Jacket Color
	<p>1= 120VAC 2= 240VAC</p> <p>* 240 volt cables can be powered at 208, 240 or 277 volts</p>	<p>1= Class I, Division 1 Areas</p> <p>2= General Purpose/Class I, Division 2 Areas</p>	<p>Low/High</p> <p>A= -40°F/80°F B= -20°F/95°F C= 0°F/105°F D= 10°F/115°F</p>	<p>V=FR-PVC T=FR-TPE U=FR-PUR P=PUR R=TPR E=FRPE L=LDPE F=PVDF</p> <p>Note: Parflex standard jacket material is FR-PVC</p>	<p>4=140°F Jacket 6=160°F Jacket 8= 180°F Jacket</p> <p>* Jacket surface temperature will not exceed this maximum when the bundle is operated at the designed steam purge temperature at the highest ambient design condition</p>	<p>N=Black B=Blue G=Green O=Orange Y=Yellow P=Purple R=Red W=White</p> <p>Note: Parflex standard color jacket is black</p>					



WARNING

This product can expose you to chemicals including Antimony Oxide (Antimony Trioxide), which is known to the State of California to cause cancer. For more information go to www.P65Warnings.ca.gov.

Part Number #	Process Tube O.D. (in.) 	Wall Thickness (in.) 	Nominal Product O.D. (in.) 	Product Weight (lbs./ft.) 	Min. Bend Radius (in.) 	Watt Density per foot/Voltage	Circuit Length Ft @ 50°F / Breaker (amps), 120V	Performance At Low Ambient Conditions	Maximum Allowable Continous Steam Purge	Max. Jacket Surface Temp. during Steam Purge & High Ambient 80°F (26.6°C)
						Watt/FT	 @ 120V**	At -40°F (-40°C) will maintain at least freeze protection***	Continuous Steam Purge	

CS – Continuous Steam Purge – Single Process Tube Seamless Stainless Steel*, ASTM A269

CS-B0849A-612A-V8N	(1) 1/2"	0.049"	1.61	0.55	10	10	250 Ft. / 40 Amp	40°F (4.4°C)	650°F (343°C)	180°F (82°C)
CS-B0849A-712A-V8N	(1) 1/2"	0.049"	1.85	0.59	11	10	250 Ft. / 40 Amp	40°F (4.4°C)	750°F (399°C)	180°F (82°C)
CS-B0849A-812A-V8N	(1) 1/2"	0.049"	2.01	0.61	12	15	190 Ft. / 40 Amp	40°F (4.4°C)	850°F (454°C)	180°F (82°C)
CS-B0849A-912A-V8N	(1) 1/2"	0.049"	2.17	0.63	13	15	190 Ft. / 40 Amp	40°F (4.4°C)	950°F (510°C)	180°F (82°C)

CS – Continuous Steam Purge – Dual Process Tube Seamless Stainless Steel*, ASTM A269

CS-B0849B-612A-V8N	(2) 1/2"	0.049"	2.09	0.86	13	10	250 Ft. / 40 Amp	40°F (4.4°C)	650°F (343°C)	180°F (82°C)
CS-B0849B-712A-V8N	(2) 1/2"	0.049"	2.25	0.88	13	10	250 Ft. / 40 Amp	40°F (4.4°C)	750°F (399°C)	180°F (82°C)
CS-B0849B-812A-V8N	(2) 1/2"	0.049"	2.49	0.92	15	15	190 Ft. / 40 Amp	40°F (4.4°C)	850°F (454°C)	180°F (82°C)
CS-B0849B-912A-V8N	(2) 1/2"	0.049"	2.69	1.04	16	15	190 Ft. / 40 Amp	40°F (4.4°C)	950°F (510°C)	180°F (82°C)

*Many other alloys available, as well as seamless stainless steel tubing.

**Product is also available in 208, 240 and 277V

***As ambient conditions go above -40°F (-40°C) , without use of a controller the product could maintain higher temperatures.



FM – Factory Mutual

General Purpose - Ordinary Locations
Hazardous Locations, when installed with Parflex accessories.

- Class I, Div. 2, Groups B, C and D (gases, vapors)
- Class II, Div.2, Group F, G (Combustible dust)
- Class III, Div.2, (ignitable fibers and filings)

T-Temperature Ratings

- 3, 5 and 8 watt rated T3 temperature class
- 10, 15 and 20 watt rated T2D temperature class

CSA – Canadian Standards Association

CSA Certified for ordinary locations
For certified hazardous locations contact Parflex

ATEX - Certified Cables & accessories available

Electrical Specifications:

Operating Voltage: 120 V or 240V
Bus Wire Voltage Rating: 600 Volts
Bus Wire Size: 14 AWG



WARNING

This product can expose you to chemicals including Antimony Oxide (Antimony Trioxide), which is known to the State of California to cause cancer. For more information go to www.P65Warnings.ca.gov.

Section 3 —

CL— Constant Wattage Electric Trace Tubing for Low Temperature Maintenance

Maintain Temperatures up to 250°F (121°C) and withstand Maximum Internal Exposure up to 400°F (204°C)



General

Parflex CL Constant Wattage Temptrace™ electric trace tubing consists of a process tube traced with a constant wattage heating cable, a heat transfer foil wrap, nonhygroscopic glass fiber insulation and a black, 105°C-rated, flame-resistant PVC (FR-PVC) jacket.

Parflex CL-Temptrace™ is designed for various temperature ranges including:

- Freeze protection and viscosity maintenance of 50°F (10°C) at ambient temperatures of -40°F (-40°C)
- Low process temperature maintenance from 160°F (71.1°C) to 250°F (121.1°C) at -40°F (-40°C) to 80°F (26.7°C) ambient conditions.

Standard product has a Maximum Temperature Rating (MTR*) of 400° F (204.4°C) when power to the heating cable is off, and 250°F (121.1°C) when power to the heating cable is on. See CH-Constant Wattage design for higher temperature ranges.

*Maximum Temperature Rating is the maximum allowable temperature of the tracing fluid. Temperatures in excess of this may damage the product or alter its performance.

Applications

CL-Temptrace™ is ideal for analyzer, impulse and instrument lines; small diameter process lines; stack gas sampling lines; and utility lines.

Tubing

Type 122 DHP Seamless Copper, 316/316L Welded and Seamless Stainless Steel, PFA, FEP and PTFE are standard. Wall thicknesses are available upon request. For Material Specifications of metal tubing, see *Technical Data* in Section of the catalog. Consult Division for details.

Heat Transfer Foil

An aluminum heat transfer foil allows for even heat distribution for precise temperature control.

Insulation

Air-spaced, cross wrapped applied non-hygroscopic fiberglass thermal insulation provides minimum heat loss.

Jacket

The 105°C-rated, flame-resistant PVC (FR-PVC) jacket protects the tubing against corrosive atmospheres, water, oils, acids, alkalis and most chemicals. Additional jacket materials are available upon request. For Material Specifications of jackets, see *Technical Data* in Section of the catalog. Consult Division for additional details.

Testing

Each tube in every length of Parflex Temptrace™ is pressure tested prior to shipment to assure the instrument engineer a high-quality, reliable, trouble-free product. For Testing Specifications, see *Technical Data* in Section of the catalog.

Accessories

Accessories are available for electrical connections, bundle splicing and end terminations. Accessories for constant wattage bundles are identified in this section.

Ordering

See the following page for information about how to specify and order.

NOTE: It is absolutely necessary to seal the ends against contamination from moisture and/or corrosive liquids. Parker Hannifin cannot assume any liability for product damage caused by moisture from unsealed ends.



WARNING

This product can expose you to chemicals including Antimony Oxide (Antimony Trioxide), which is known to the State of California to cause cancer. For more information go to www.P65Warnings.ca.gov.

How to Specify & Order

CL-Constant Watt Low Temperature Maintenance Electric Trace Bundles

Maintain Temperatures up to 250°F (121°C) with a Maximum Internal Exposure up to 400°F (204°C)

CL - 4 1 2 - B 08 35 B - V B

CL Bundle Type	4 Heating Cable (Watt/ft)	1 Heating Cable Voltage	2 Area Classification	B Process Tube Material
CL= Constant Watt Low Temperature	See Selection Chart 4= 4 watt 8= 8 watt 2= 12 watt ?= 16 watt C= 18 watt	1= 120VAC 2= 240VAC 8= 208VAC	2= General Purpose & FM Class I, Division 2 Areas	1= Smls Copper Type DHP Alloy No 122. ASTM B68/B75 2= Welded Stainless Steel Type 316/316L ASTM A269 3= Welded Stainless Steel Type 304 ASTM A269 B= Smls 316/316L ASTM A269 C= Smls 304 ASTM A269 D= Smls Monel Type 400 E= Smls Hastelloy C22 K= Smls 36H ASTM A213 L= Smls Incoloy 825 M= Electropolish Smls 316/316L ASTM A269 (10Ra Max) M=Smls 316/316L ASTM A213 S= Silco Smls 316/316L Stainless ASTM A269 P= PFA Fluoropolymer F= FEP Fluoropolymer T= TFE Fluoropolymer 7= Parflex 919 PTFE SS Braided Hose 9= Customer Specified Tube Material

08 Process Tube Size	35 Process Tube Size	B Number of Process Tubes	V Jacket Material	B Jacket Color
O.D. See Charts Imperial 02=1/8" 03=3/16" 04=1/4" 05=5/16" 06=3/8" 07=7/16" 08=1/2" 10=5/8" 12=3/4" 16=1" Metric MA=2mm MB=4mm MC=6mm MD=8mm ME=10mm MF=12mm MG=14mm MH=16mm	Wall Thickness See Charts Imperial 16=.016" 20=.020" 28=.028" 30=.030" 34=.031" 32=.032" 35=.035" 4=.040" 47=.047" 49=.049" 50=.050" 62=.062" 65=.065" 83=.083" Metric 89=.89mm 10=1.0mm 15=1.5mm 20=2.0mm 25=2.5mm	A= 1Tube B= 2 Tubes C=3 Tubes etc. P= 2 Tube Parallel Design	V = FR-PVC T = FR-TPE U = FR-PUR P = PUR R = TPR E = FRPE L = LDPE F = PVDF Note: Parflex standard jacket material is FR-PVC	N=Black B=Blue G=Green O=Orange Y=Yellow P=Purple R=Red W=White Note: Parflex standard color jacket is black Note: For standard black FR-PVC jacketed product -VN may be dropped



WARNING

This product can expose you to chemicals including Antimony Oxide (Antimony Trioxide), which is known to the State of California to cause cancer. For more information go to www.P65Warnings.ca.gov.

Electrical Specifications:

Heater type	4 W./ft.	11.4W./ft.
Insulation	PFA Teflon® 600 V rated	PFA Teflon® 600V rated
Bus wire size	12 AWG	12 AWG
Heating zone length**	18" (45.7 cm) and 24" (61 cm)	

Part Number Series	Power Consumption W/ft (W/m)	Voltage	Maximum Circuit Length* ft (m) 	Current A/ft (A/m)
CL	4 (13.1)	120	340 (103.6)	0.033 (0.108)
		240	680 (207.3)	0.017 (0.054)
CL	11.4 (37.4)	120	200 (61)	0.095 (0.292)
		240	400 (122)	0.0485 (0.156)

****Installation Note:**

Caution: Cutting beyond heating zone indentation will result in an unheated section of the heater wire for the balance of the heating zone length. The bus wires **MUST NOT** be connected together on the termination end!

For recommended temperature controller, see 4012-01145 (G.I. areas) and 4012-01147 (Hazardous locations) on page 31.

Approvals:

Ordinary Locations

FM – Factory Mutual Approved
 Hazardous (Classified) Locations
 FM – Factory Mutual Approved

Class I, Division 2, Groups B, C and D
 Class II, Division 1, Groups F and G
 Class III, Division 1 and 2

Ground Fault Equipment Protection Devices (GFEPDs):

The IEEE standard (515-1989) for heating cables requires the use of GFEPDs with a nominal 30 milliampere trip level for “piping systems in classified areas, those areas requiring a high degree of maintenance, or which may be exposed to physical abuse or corrosive atmospheres.”

For performance characteristics see next page.

Performance Data—Single Process Tube

CL Constant Watt Low Temperature Heater 4 watt/ft - Single Tube Designs

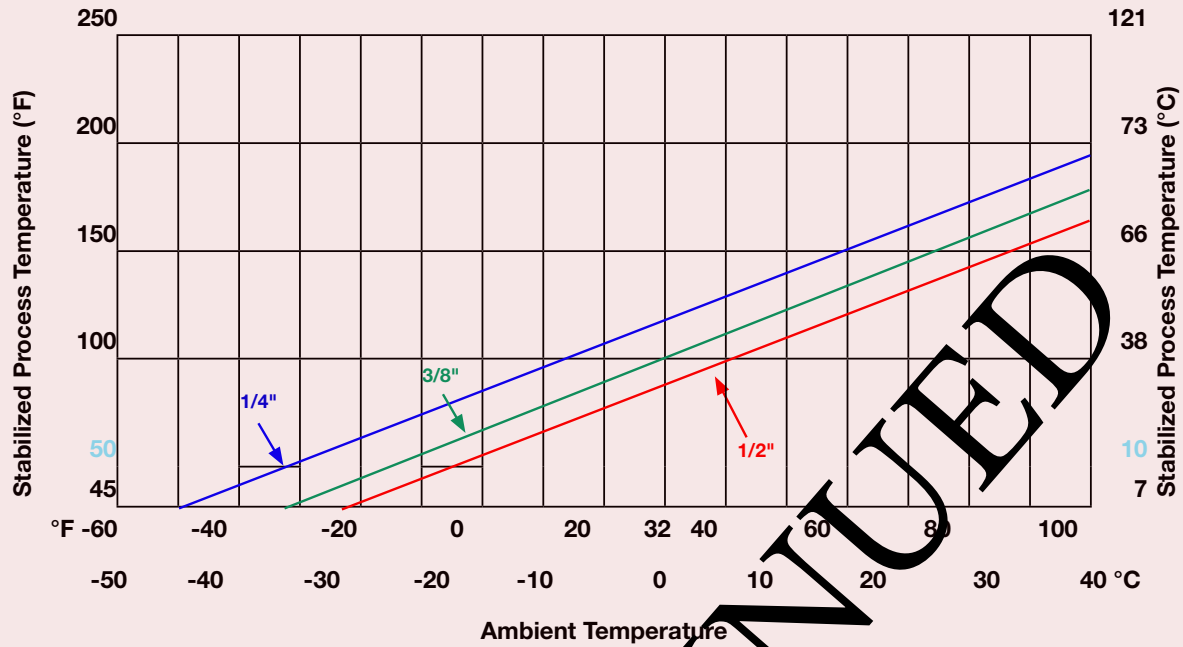

Performance Data—Dual Process Tube

CL Constant Watt Low Temperature Heater 4 watt/ft - Dual Tube Designs

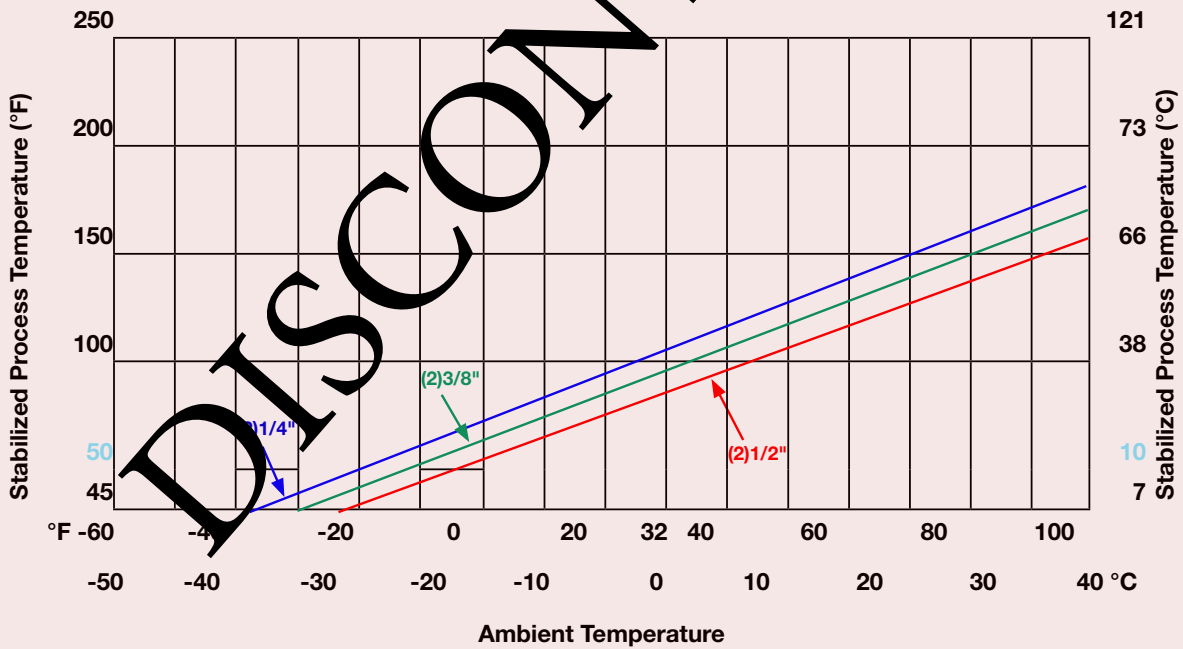

CL Series Constant Watt Bundles
Maximum Exposure 400°F (204°C)
Process Tubes 1/4" to 1/2" O.D. (6mm to 12mm)
Single or Dual Tube Designs

Minimum Process Temperature to Maintain	Standard Insulation Package *				
	Environments Average High / Low Ambient Conditions				
	Extreme Cold	Cold	Moderate Cold	Moderate	Warm
	-65°F Low 80°F High	-40°F Low 80°F High	-10°F Low 95°F High	0°F Low 105°F High	10°F Low 115°F High
120 Volts	-54°C Low 26°C High	-40°C Low 26°C High	-24°C Low 35°C High	-18°C Low 40°C High	-13°C Low 46°C High
40°F (4°C)	8 Watt / Ft	8 Watt / Ft	4 Watt / Ft	4 Watt / Ft	4 Watt / Ft
50°F (10°C)	11.4 Watt / Ft	8 Watt / Ft	8 Watt / Ft	4 Watt / Ft	4 Watt / Ft
75°F (24°C)	11.4 Watt / Ft	11.4 Watt / Ft	8 Watt / Ft	8 Watt / Ft	8 Watt / Ft
100°F (38°C)	18 Watt / Ft	11.4 Watt / Ft	11.4 Watt / Ft	8 Watt / Ft	8 Watt / Ft
125°F (52°C)	18 Watt / Ft	18 Watt / Ft	11.4 Watt / Ft	11.4 Watt / Ft	11.4 Watt / Ft
150°F (66°C)	18 Watt / Ft	18 Watt / Ft	18 Watt / Ft	18 Watt / Ft	11.4 Watt / Ft
175°F (79°C)		18 Watt / Ft	18 Watt / Ft	18 Watt / Ft	18 Watt / Ft
200°F (93°C)			18 Watt / Ft	18 Watt / Ft	18 Watt / Ft
225°F (107°C)			18 Watt / Ft	18 Watt / Ft	18 Watt / Ft
208 Volts					
40°F (4°C)	8 Watt / Ft	8 Watt / Ft	4 Watt / Ft	4 Watt / Ft	4 Watt / Ft
50°F (10°C)	11.4 Watt / Ft	8 Watt / Ft	8 Watt / Ft	4 Watt / Ft	4 Watt / Ft
75°F (24°C)	11.4 Watt / Ft	11.4 Watt / Ft	15 Watt / Ft	8 Watt / Ft	8 Watt / Ft
100°F (38°C)	18 Watt / Ft	11.4 Watt / Ft	15 Watt / Ft	8 Watt / Ft	8 Watt / Ft
125°F (52°C)		18 Watt / Ft	11.4 Watt / Ft	11.4 Watt / Ft	11.4 Watt / Ft
150°F (66°C)			18 Watt / Ft	11.4 Watt / Ft	11.4 Watt / Ft
175°F (79°C)				18 Watt / Ft	18 Watt / Ft
240 Volts					
40°F (4°C)	8 Watt / Ft	8 Watt / Ft	4 Watt / Ft	4 Watt / Ft	4 Watt / Ft
50°F (10°C)	11.4 Watt / Ft	8 Watt / Ft	8 Watt / Ft	4 Watt / Ft	4 Watt / Ft
75°F (24°C)	11.4 Watt / Ft	11.4 Watt / Ft	8 Watt / Ft	8 Watt / Ft	8 Watt / Ft
100°F (38°C)	18 Watt / Ft	11.4 Watt / Ft	11.4 Watt / Ft	8 Watt / Ft	8 Watt / Ft
125°F (52°C)	18 Watt / Ft	18 Watt / Ft	11.4 Watt / Ft	11.4 Watt / Ft	11.4 Watt / Ft
150°F (66°C)	18 Watt / Ft	18 Watt / Ft	18 Watt / Ft	18 Watt / Ft	11.4 Watt / Ft
175°F (79°C)		18 Watt / Ft	18 Watt / Ft	18 Watt / Ft	18 Watt / Ft
200°F (93°C)			18 Watt / Ft	18 Watt / Ft	18 Watt / Ft
225°F (107°C)			18 Watt / Ft	18 Watt / Ft	18 Watt / Ft

* The above heater cable selection is based upon our standard insulation package. Other insulation packages are available to maintain higher temperatures.

How to Use:

- 1) Check to be sure you are using the correct chart.
- 2) Choose your operating voltage.
- 3) Choose the minimum process temperature you want to maintain.
 Note: If temperature is not shown, pick the next higher option.
- 4) Follow chart across to the ambient Condition that best match your area.
- 5) Use the watt-density shown for your part number derivation.

Note:

The watt-density selected will maintain the temperature indicated at a minimum. Depending upon actual ambient fluctuations, process tubes size and number of tubes, the maintenance temperature could be higher.

CH— Constant Wattage Electric Trace Tubing for High Temperature Maintenance

Maintain Temperatures up to 400°F (204°C) and withstands Maximum Internal Exposure to 400°F (204°C)



General

Parflex CH Constant Wattage Temprace™ electric trace tubing consists of a process tube, or tubes, traced with a constant wattage heating cable, a heat transfer foil wrap, nonhygroscopic glass fiber insulation and a black, 105°C-rated, flame-resistant PVC (FR-PVC) jacket.

Parflex CH-Temprace™ is designed for process temperature maintenance from 160°F (71°C), at -40°F (-40°C) ambient temperatures, to 400°F (204°C), at 80°F (26.7°C) ambient. Contact the factory for complete design capabilities for your application.

Standard product has a Maximum Temperature Rating* (MTR) of 400°F (204.4°C) when power to the heating cable is on. Consult Division for details.

*Maximum Temperature Rating is the maximum allowable temperature of the tracing fluid. Temperatures in excess of this may damage the product or alter its performance.

Applications

CH-Temprace™ is ideal for analyzer, impulse and instrument lines; small diameter process lines; stack gas sampling lines; and utility lines.

Tubing

Type 122 DHP Seamless Copper, 316/316L Welded and Seamless Stainless Steel, FEP, PFA and PTFE are standard. Special wall thicknesses are available upon request. For Material Specifications of metal tubing, see *Technical Data* Section.

Tubing Identification

When process tubes are the same size and material, each individual tube is printed with a tube number at two-inch intervals or tubes are color coded.

Heat Transfer Foil

An aluminum heat transfer foil allows for even heat distribution for precise temperature control.

Insulation

Air-spaced, cross wrapped applied non-hygroscopic fiberglass thermal insulation provides minimum heat loss.

Jacket

The tough, black, 105°C-rated, flame-resistant PVC (FR-PVC) jacket protects the tubing against corrosive atmospheres, water, oils, acids, alkalis and most chemicals. Additional jacket materials are available upon request. For Material Specifications of jackets, see *Technical Data* Section of the catalog.

Testing

Each tube in every length of Parflex Temprace™ is pressure tested prior to shipment to assure the instrument engineer a high quality, reliable, trouble-free product. For Testing Specifications, see *Technical Data* Section of the catalog.

Accessories

Accessories are available for electrical connections, bundle splicing and end terminations. Accessories for constant wattage bundles are identified in this section.

Ordering

See the following page for information about how to specify and order.

NOTE: It is absolutely necessary to seal the ends against contamination from moisture and/or corrosive liquids. Parker Hannifin cannot assume any liability for product damage caused by moisture from unsealed ends.



WARNING

This product can expose you to chemicals including Antimony Oxide (Antimony Trioxide), which is known to the State of California to cause cancer. For more information go to www.P65Warnings.ca.gov.

How to Specify & Order

CH-Constant Watt High Temperature Maintenance Electric Trace Bundles

Maintain Temperatures up to 400°F (204°C) with a Maximum Internal Exposure up to 400°F (204°C)

CH - 4 1 2 - B 08 35 B - V B

CH	Bundle Type	4	Heating Cable (Watt/ft)	1	Heating Cable Voltage	2	Area Classification	B	Process Tube Material
	CL= Constant Watt High Temperature		See Selection Chart 4= 4 watt 8= 8 watt 2= 12 watt ?= 16 watt C= 18 watt		1= 120VAC 2= 240VAC 8= 208VAC		2= General Purpose & FM Class I, Division 2 Areas		1= Smls Copper Type DHP Alloy No 122. ASTM B68/B75 2= Welded Stainless Steel Type 316/316L ASTM A269 3= Welded Stainless Steel Type 304 ASTM A269 4= Smls 316/316L ASTM A269 5= Smls 304 ASTM A269 6= Smls Monel Type 400 7= Smls Hastelloy C22 8= Smls 316H ASTM A213 9= Smls Incoloy 825 L= Electropolish Smls 316/316L ASTM A269 (10Ra Max) M= Smls 316/316L ASTM A213 S= Silco Smls 316/316L Stainless ASTM A269 P= PFA Fluoropolymer F= FEP Fluoropolymer T= TFE Fluoropolymer 7= Parflex 919 PTFE SS Braided Hose 9= Customer Specified Tube Material

08	Process Tube Size	35	Process Tube Size	B	Number of Process Tubes	V	Jacket Material	B	Jacket Color
	O.D.		Wall Thickness		A= 1Tube B= 2 Tubes C= 3 Tubes etc.		V = FR-PVC T = FR-TPE U = FR-PUR P = PUR R = TPR E = FRPE L = LDPE F = PVDF		N=Black B=Blue G=Green O=Orange Y=Yellow P=Purple R=Red W=White
	See Charts		See Charts		P= 2 Tube Parallel Design		Note: Parflex standard jacket material is FR-PVC		Note: Parflex standard color jacket is black
	Imperial		Imperial						Note: For standard black FR-PVC jacketed product -VN may be dropped
	02=1/8" 03=3/16" 04=1/4" 05=5/16" 06=3/8" 07=7/16" 08=1/2" 10=5/8" 12=3/4" 16=1"		15=.020" 20=.020" 28=.021" 30=.030" 31=.021" 32=.032" 35=.035" 40=.040" 47=.047" 49=.049" 50=.050" 62=.062" 65=.065" 83=.083"						
	Metric		Metric						
	MA=3mm MB=4mm MC=6mm MD=8mm ME=10mm MF=12mm MG=14mm MH=16mm		89=.89mm 10=1.0mm 15=1.5mm 20=2.0mm 25=2.5mm						



WARNING

This product can expose you to chemicals including Antimony Oxide (Antimony Trioxide), which is known to the State of California to cause cancer. For more information go to www.P65Warnings.ca.gov.

Electrical Specifications:

Heater type	12 W./ft.	18 W./ft.
Insulation	Kapton®	Kapton®
Bus wire size	12 AWG	12 AWG
Heating zone length**	Average 48" (121.9 cm) for high temperature Kapton® insulated heater wires	

Part Number Series	Power Consumption W/ft (W/m)	Voltage	Maximum Circuit Length* ft (m)	Current A/ft (A/m)
CH	12 (39.3)	120	180 (54.9)	0.100 (0.3281)
		240	360 (109.7)	0.050 (0.154)
CH	18.0 (58.95)	120	147 (44.8)	0.150 (0.457)
		240	294 (89.6)	0.075 (0.228)

*Based on 10% power drop

****Installation Note:**

Caution: Cutting beyond heating zone indentation will result in an unheated section of the heater wire for the balance of the heating zone length. The bus wires **MUST NOT** be connected together on the termination end!

For recommended temperature controller, see 4012-01115 (G.P. areas) and 4012-01147 (Hazardous locations) on page 31.

Approvals:

Ordinary Locations

FM – Factory Mutual Approved

Hazardous (Classified) Locations

FM – Factory Mutual Approved

Class I, Division 2, Groups B, C, and D

Class II, Division 2, Groups F and G

Class III, Division 1 and 2

Ground Fault Equipment Protection Devices (GFEPDs):

The IEEE standard (515-1989) for heating cables requires the use of GFEPDs with a nominal 30 milliampere trip level for “piping systems in classified areas, those areas requiring a high degree of maintenance, or which may be exposed to physical abuse or corrosive atmospheres.”

Performance Data—Single Process Tube

CH Constant Watt Low Temperature Heater 8 watt/ft - Single Tube Designs

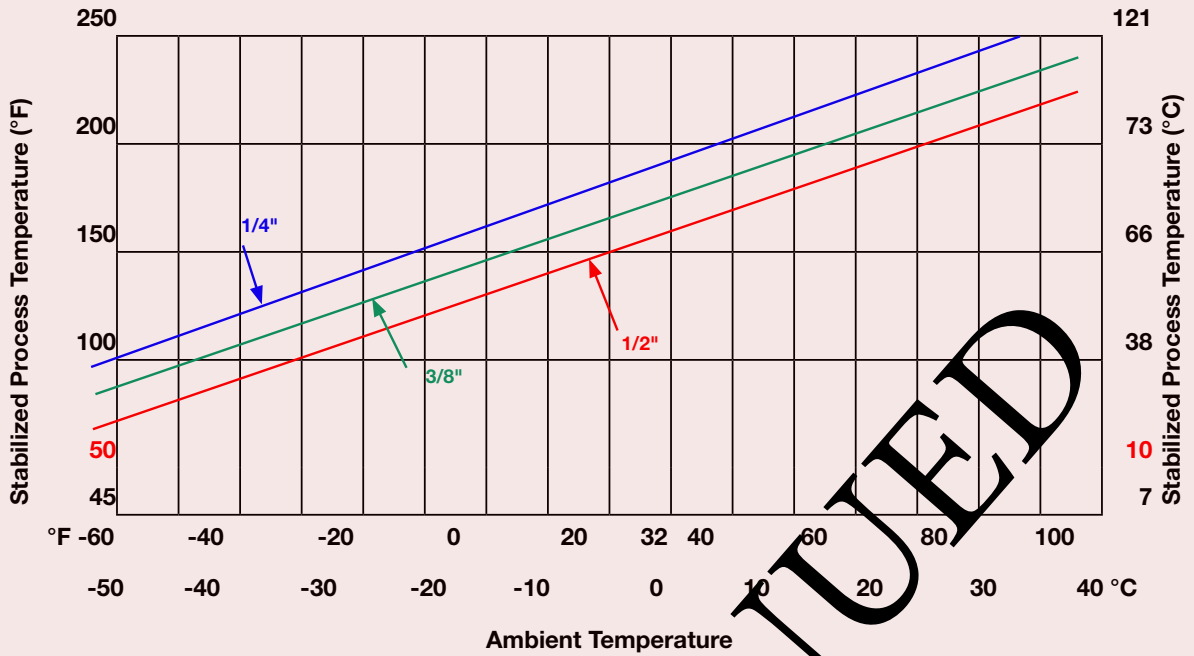

Performance Data—Dual Process Tube

CH Constant Watt High Temperature Heater 8 watt/ft - Dual Tube Designs

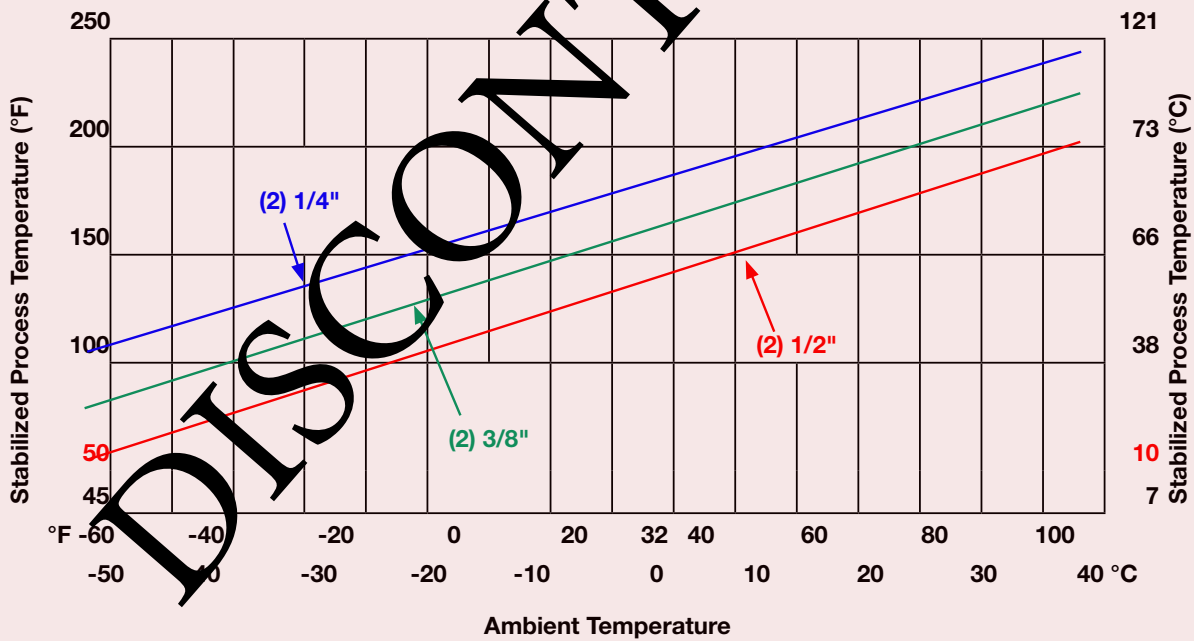

CH Series Constant Watt Bundles
Maximum Exposure 400°F (200°C)
Process Tubes 1/4" to 1/2" O.D. (6mm to 12mm)
Single or Dual Tube Designs

Minimum Process Temperature to Maintain	Standard Insulation Package*				
	Environments Average High / Low Ambient Conditions				
	Extreme Cold	Cold	Moderate Cold	Moderate	Warm
	-65°F Low 80°F High	-40°F Low 80°F High	-10°F Low 95°F High	0°F Low 105°F High	10°F Low 115°F High
120 Volts	-54°C Low 26°C High	-40°C Low 26°C High	-24°C Low 35°C High	-18°C Low 40°C High	-13°C Low 46°C High
250°F (4°C)	18 Watt / Ft	18 Watt / Ft	18 Watt / Ft	12 Watt / Ft	12 Watt / Ft
275°F (10°C)	18 Watt / Ft	18 Watt / Ft	18 Watt / Ft	18 Watt / Ft	12 Watt / Ft
300°F (24°C)	18 Watt / Ft	18 Watt / Ft	18 Watt / Ft	18 Watt / Ft	18 Watt / Ft
325°F (38°C)	18 Watt / Ft	18 Watt / Ft	18 Watt / Ft	18 Watt / Ft	18 Watt / Ft
350°F (52°C)		18 Watt / Ft	18 Watt / Ft	18 Watt / Ft	18 Watt / Ft
375°F (66°C)			18 Watt / Ft	18 Watt / Ft	18 Watt / Ft
400°F (79°C)				18 Watt / Ft	18 Watt / Ft
208 Volts					
250°F (4°C)	18 Watt / Ft	18 Watt / Ft	12 Watt / Ft	12 Watt / Ft	12 Watt / Ft
275°F (10°C)	18 Watt / Ft	18 Watt / Ft	18 Watt / Ft	18 Watt / Ft	12 Watt / Ft
300°F (24°C)	18 Watt / Ft	18 Watt / Ft	18 Watt / Ft	18 Watt / Ft	18 Watt / Ft
325°F (38°C)	18 Watt / Ft	18 Watt / Ft	18 Watt / Ft	18 Watt / Ft	18 Watt / Ft
350°F (52°C)		18 Watt / Ft	18 Watt / Ft	18 Watt / Ft	18 Watt / Ft
375°F (66°C)			18 Watt / Ft	18 Watt / Ft	18 Watt / Ft
400°F (79°C)				18 Watt / Ft	18 Watt / Ft
240 Volts					
250°F (4°C)	18 Watt / Ft	18 Watt / Ft	12 Watt / Ft	12 Watt / Ft	12 Watt / Ft
275°F (10°C)	18 Watt / Ft	18 Watt / Ft	18 Watt / Ft	18 Watt / Ft	12 Watt / Ft
300°F (24°C)	18 Watt / Ft	18 Watt / Ft	18 Watt / Ft	18 Watt / Ft	18 Watt / Ft
325°F (38°C)	18 Watt / Ft	18 Watt / Ft	18 Watt / Ft	18 Watt / Ft	18 Watt / Ft
350°F (52°C)		18 Watt / Ft	18 Watt / Ft	18 Watt / Ft	18 Watt / Ft
375°F (66°C)			18 Watt / Ft	18 Watt / Ft	18 Watt / Ft
400°F (79°C)				18 Watt / Ft	18 Watt / Ft

*The above heater selection is based upon our standard insulation package. Other insulation packages are available upon request. All CH series products should be installed with temperature sensor and over temperature protection devices to prevent overheating.

How to Use:

- 1) Check to be sure you are using the correct chart.
- 2) Choose your operating voltage.
- 3) Choose the minimum process temperature you want to maintain.
 Note: If temperature is not shown, pick the next higher option.
- 4) Follow chart across to the ambient Condition that best match your area.
- 5) Use the watt-density shown for your part number derivation.

Note:

The watt-density selected will maintain the temperature indicated at a minimum. Depending upon actual ambient fluctuations, process tubes size and number of tubes, the maintenance temperature could be higher.

MI - Mineral Insulated Electric Trace Tubing for High Temperature Maintenance

Maintain Temperatures up to 900°F (482°C) and withstand Maximum Internal Exposure of 1000°F (538°C)



General

Parflex MI-Mineral Insulated electric trace tubing consists of a single process tube electrically traced with a series resistance, mineral-insulated heating cable; a heat transfer foil wrap; nonhygroscopic glass fiber insulation; and a black, 105°C-rated, flame-resistant PVC (FR-PVC) jacket.

Parflex Mineral Insulated tubing is designed for various temperature ranges including:

- Freeze protection and viscosity maintenance from 40°F (4.4°C) to 80°F (26.7°C) at ambient temperatures down to -60°F (-51.1°C)
- Process temperature maintenance from 120°F (48.9°C) to 170°F (76.7°C) at -60°F (-51.1°C)
- Process temperature maintenance from 200°F (126.7°C) to 310°F (154.4°C) at 80°F (26.7°C).

Standard product has a Maximum Temperature Rating (MTR*) of 400°F (204.4°C). Higher temperature rated designs are available (up to 900°F). Consult the Division for details.

*Maximum Temperature Rating is the maximum allowable temperature of the tracing fluid. Temperatures in excess of this may damage the product or alter its performance.

Parflex Multitube® Mineral Insulated electric trace tubing is a made-to-length product and should not be cut in the field.

Applications

Analyzer, impulse and instrument lines; small diameter process lines; stack gas sampling lines; and utility lines.

Tubing

Type 122 DHP Seamless Copper and 316/316L Welded and Seamless Stainless Steel are standard. Additional materials and wall thicknesses are available upon request. For Material Specifications of metal tubing, see *Technical Data* section of the catalog. Consult Division for details.

Heat Transfer Foil

An aluminum heat transfer foil allows for even heat distribution for precise temperature control.

Insulation

Air spaced, cross wrapped applied non-hygroscopic fiberglass thermal insulation or a high temperature composite dual insulation system provides minimum heat loss.

Jacket

The tough, black, 105°C-rated, flame-resistant PVC (FR-PVC) jacket protects the tubing against corrosive atmospheres, water, oils, acids, alkalies and most chemicals. Additional jacket materials are available upon request. For Material Specifications of jackets, see *Technical Data* section of the catalog. Consult Division for additional details.

Testing

Each tube in every length of Parflex Mineral Insulated electric trace tubing is pressure tested prior to shipment to assure the instrument engineer a high-quality, reliable, trouble-free product. For Testing Specifications, see *Technical Data* section of the catalog.



WARNING

This product can expose you to chemicals including Antimony Oxide (Antimony Trioxide), which is known to the State of California to cause cancer. For more information go to www.P65Warnings.ca.gov.

Accessories

Accessories are available for electrical connections, bundle splicing and end terminations. Consult the factory for accessories for mineral insulated bundles.

Ordering: See the following page for information about how to specify and order.

NOTE: It is absolutely necessary to seal the ends against contamination from moisture and/or corrosive liquids. Parker Hannifin cannot assume any liability for product damage caused by moisture from unsealed ends.

Electrical Specifications	
Heater Type	Series resistance, order to length
Operating Voltage	120/208/240 VAC
MI Cable Construction	Alloy 825 outer sheath, nickel clad copper bus wires, magnesium oxide insulation and nichrome heating element

Maximum Exposure Temperature (heater cable only)	
Power Off	1200°F (650°C)
Power On	1000°F (538°C)

30 watts/ft load

For recommended temperature controller, see 4012-01145 (G.P. areas) and 4012-01147 (Hazardous locations)

Area Classification

General purpose, Class I, Division 2, Groups A, B, C and D.

Ground Fault Equipment Protection Devices (GFEPDs):

The IEEE standard (515-1989) for heating cables requires the use of GFEPDs with a nominal 30 milliampere trip level for “piping systems in classified areas, those areas requiring a high degree of maintenance, or which may be exposed to physical abuse or corrosive atmospheres.”

Approvals:

FM – Factory Mutual Approved
 Ordinary Locations
 Hazardous (Classified) Locations

Class I, Division 2, Groups B, C and D
 Class II, Division 2, Groups F and G
 Class III, Division 1 and 2

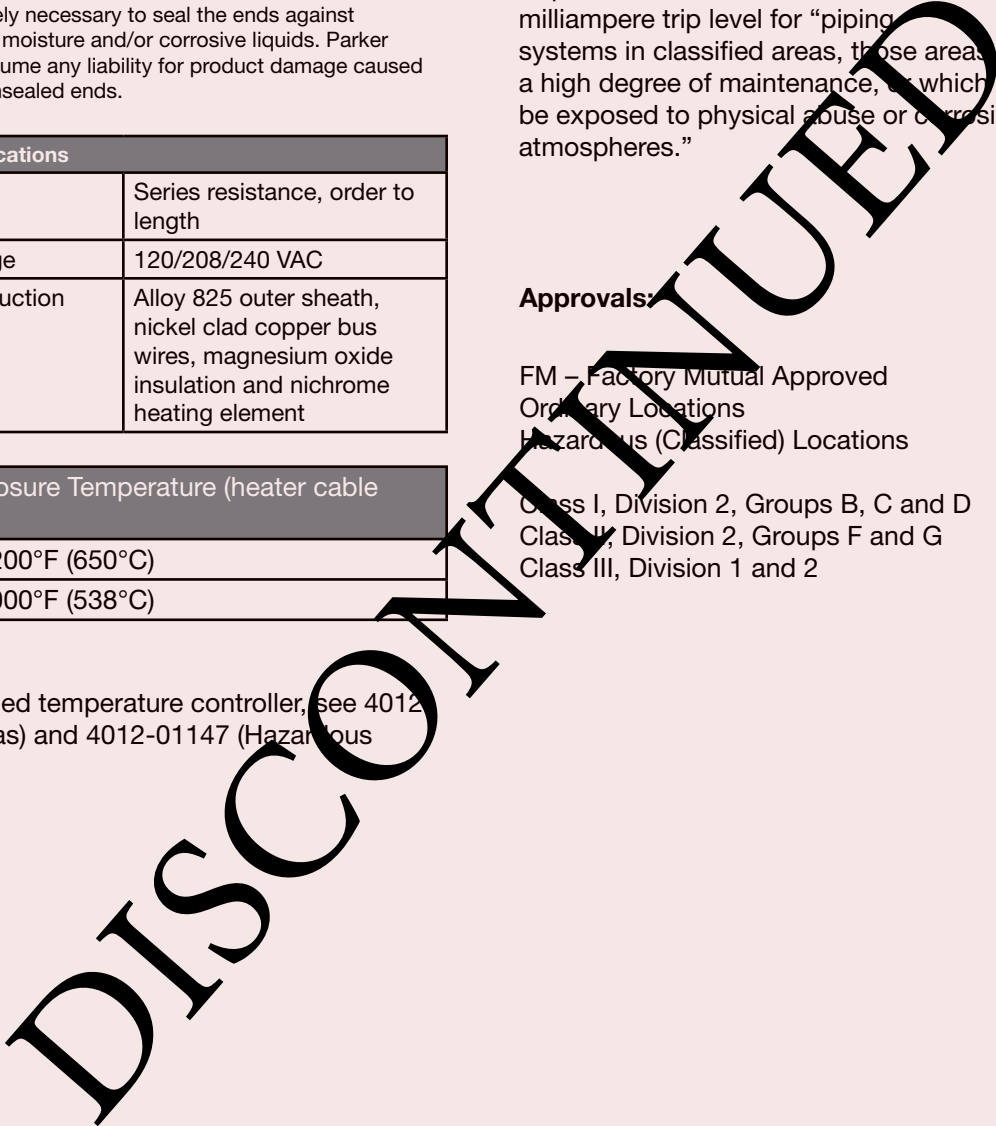

How to Specify & Order

M – Mineral Insulated Electric Trace Bundles

Maintain Temperatures up to 900°F (482°C) with High Temperature Exposure up to 1000°F (538°C)

M - 30 1 2 - B 08 49 B - V B - 125

M	Bundle Type	30	Heating Cable (Watts/ft)	1	Heating Cable Voltage	2	Area Classification	B	Process Tube Material
	M= Mineral Insulated		Mfg. to determine watts based upon customer supplied criteria		1= 120VAC 2= 240VAC 8= 208VAC 7= 277VAC		2= General Purpose & FM Class I, Div.2 Areas		1= Smls Copper Type DHP Alloy No 122. ASTM B68/B75 2= Welded Stainless Steel Type 316/316L ASTM A269 3= Welded Stainless Steel Type 304 ASTM A269 4= Smls 316/316L ASTM A269 C= Smls 304 ASTM A269 D= Smls Monel Type 400 E= Smls Hastelloy C22 H= Smls 316H ASTM A213 I= Smls Incoloy 825 L= Electropolish Smls 316/316L ASTM A269 (10Ra Max) M=Smls 316/316L ASTM A213 S= Silco Smls 316/316L Stainless ASTM A269 P= PFA Fluoropolymer F= FEP Fluoropolymer T= TFE Fluoropolymer 7= Parflex 919 PTFE SS Braided Hose 9= Customer Specified Tube Material
			The Design Criteria Required is:						
			Maintain Temperature						
			Ambient Conditions (Low/High)						
			Max. Bundle Internal Exposure Temperature						

08	Process Tube Size	49	Process Tube Size	B	Number	V	Jacket Material	B	Jacket Color	125	Installed Run Length Required
	O.D.		Wall Thickness		Process Tube		V = FR-PVC T = FR-TPE U = FR-PUR P = PUR R = TPR E = FRPE L = LDPE F = PVDF		N=Black B=Blue G=Green O=Orange Y=Yellow P=Purple R=Red W=White		=-XXX (Length in feet)
	See Charts		See Charts		A= 1 Tube B= 2 Tubes C= 3 Tubes etc.		Note: Parflex standard jacket material is FR-PVC		Note: Parflex standard color jacket is black		
	Imperial		Imperial		P= 2 Tube Parallel Design						
	02=1/8"		16=.013"								
	03=3/16"		20=.010"								
	04=1/4"		28=.008"								
	05=5/16"		28=.031"								
	06=3/8"		31=.031"								
	07=7/16"		32=.031"								
	08=1/2"		35=.035"								
	10=5/8"		40=.040"								
	12=3/4"		47=.047"								
	16=1"		48=.049"								
	Metric		50=.050"								
	MA=2mm		62=.062"								
	MB=4mm		65=.065"								
	MC=6mm		83=.083"								
	MD=8mm		Metric								
	ME=10mm		89=.89mm								
	MF=12mm		10=1.0mm								
	MG=14mm		15=1.5mm								
	MH=16mm		20=2.0mm								
			25=2.5mm								

WARNING This product can expose you to chemicals including Antimony Oxide (Antimony Trioxide), which is known to the State of California to cause cancer. For more information go to www.P65Warnings.ca.gov.

**4031-0001 Electrical Connection Kit for CL and
4031-0001B Electrical Connection Kit for CH
Series Constant Wattage Temptrace™**



Each Kit contains:

- | | |
|------------------------------------|---|
| 1 Connection Box | 1 Bracket Assembly |
| 1 Connection Box Gasket | 2 Connector unions |
| 1 Connection Box Cover | 2 Heating cable grommets |
| 1 Mounting Bracket | 2 Plastic cable ties |
| 1 3/4" Locknut | 2 Non-insulated butt splice (12-10 AWG) |
| 1 3/4" Pipe Plug | 3 Non-insulated butt splice (16-14 AWG) |
| 1 "Electric Trace" caution sticker | 2 Heater termination boots |
| 1 2.8 oz Black RTV Sealant | 1 Roll 3/4" wide temperature tape |

Description: Parker electrical connection kits are universal, all-in-one connection kits for making electrical connections (input power, splice, input power splice, and termination) for Parflex electric trace tubing bundles. The kits contain all the necessary components and hardware to make one input connection, one splice connection, one input power splice connection, as well as, two termination connections. The connection kits are designed for use in ordinary locations and Class I, Division 2, Groups B, C, and D; Class II, Division 2, Groups F and G; Class III, Divisions 1 and 2 hazardous locations.

Approvals:

FM – Factory Mutual Approved
Ordinary Locations
Hazardous (Classified) Locations

Class I, Division 2, Groups B, C and D
Class II, Division 2, Groups F and G
Class III, Division 1 and 2

Ground Fault Equipment Protection Devices (GFEPDs):

The IEEE standard (515-1989) for heating cables requires the use of GFEPDs with a nominal 30 milliampere trip level for "piping systems in classified areas, those areas requiring a high degree of maintenance, or which may be exposed to physical abuse or corrosive atmospheres."



Assembled Input Power and Splice Connection Kit



Assembled Input Power Connection Kit

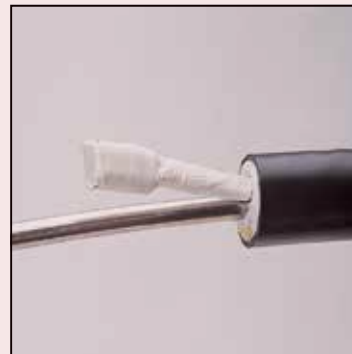

Assembled Termination Connection Kit



WARNING

This product can expose you to chemicals including Antimony Oxide (Antimony Trioxide), which is known to the State of California to cause cancer, and Ethylene Oxide, which is known to the State of California to cause birth defects or other reproductive harm. For more information go to www.P65Warnings.ca.gov.

Constant Wattage Products Accessory Selections

Product Family	Series	Accessory P/N	Description
Constant Wattage Temptrace™	CL & CH	4031-0001	Electrical Input Power / End Termination Kit
		4031-0001B	Electrical Input Power / End Termination Kit
		4012-01145	Line sensing general purpose area NEMA 4X temperature controller
		4012-01147	Line sensing hazardous location NEMA 7 temperature controller
		RTV-103BLK	End Sealant, 2.8 oz. tube, 400°F
		RTV-103BLK10.3	End Sealant, 10.1 oz. cartridge, 400°F
		RTV-106RED	End Sealant, 2.8 oz. tube, 500°F
		ESB	End Seal Boot, 400°F molded silicone
		SK-612	Splice or fitting / valve end termination kit (Insulation dimensions - 6" x 12")
		SK-630	Splice or fitting / valve end termination kit (Insulation dimensions - 6" x 30")
		SK-696	Splice or fitting / valve end termination kit (Insulation dimensions - 6" x 30")
		PTFT1.45	Parflex Temptrace™ Feed Through seal kit (.79" - 1.45")
		PTFT2.42	Parflex Temptrace™ Feed Through seal kit (1.45" - 2.42")

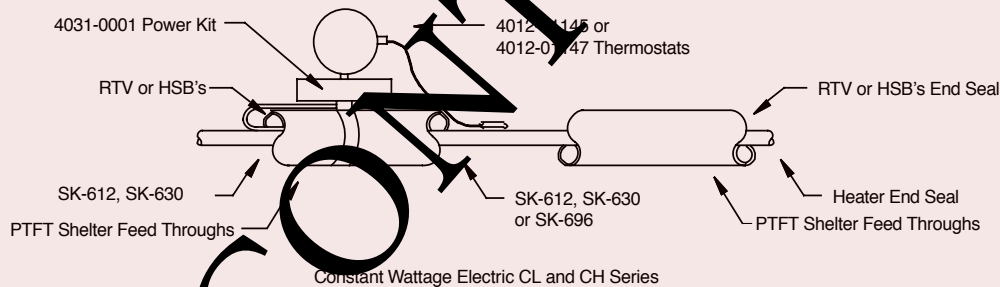

Specifications Conformance

Electric Trace Tubing Products

Parflex Multitube® Temptrace™ electric trace products conform to *Articles 427 and 500 of the National Electric Code*. Article 427 is entitled, "Fixed Electric Heating Equipment for Pipelines and Vessels." Article 500 is entitled, "Hazardous (classified) Locations," and contains definitions of specific occupancies by Class, Division and Group Location.

Parflex Multitube® Temptrace™ electric trace products also conform to IEEE Standard 515 entitled, "IEEE Recommended Practice for the Testing, Design, Installation and Maintenance of Electrical Resistance Heat Tracing for Industrial Applications."

Ground Fault Equipment Protection Devices (GFEPDs):

The IEEE standard (515-1989) for heating cables requires the use of GFEPDs with a nominal 30 milliampere trip level for "piping systems in classified areas, those areas requiring a high degree of maintenance, or which may be exposed to physical abuse or corrosive atmospheres."



WARNING

This product can expose you to chemicals including Antimony Oxide (Antimony Trioxide), which is known to the State of California to cause cancer, and Ethylene Oxide, which is known to the State of California to cause birth defects or other reproductive harm. For more information go to www.P65Warnings.ca.gov.

Parflex Electric Trace Design Criteria Quote Request

Fax Inquiry To: Sales Office
330-296-6747

Date: _____ Customer Name: _____

Bundle Type: CL Temptrace™ (Low Temperature Maintenance up to 250° F (121°C))
 CH Temptrace™ (High Temperature Maintenance up to 400° F (204° C))
 MI Temptrace™ (High Temperature Maintenance over 1000° F (538° C))

Total Quantity: _____ Feet
 _____ Meters

Specified Lengths: _____

Part Number: _____ (See How-to-Order in applicable product section.)

If not sure of part number, complete the following criteria:

Maximum Temperature to be maintained: _____ ° ()

Lowest ambient temperature: _____ ° ()

Highest ambient temperature: _____ ° ()

What is the maximum internal process tube or steam surge temperature? _____ ° ()

Process Tubes:

How many process tubes: _____
 Size: (O.D. and wall thickness): _____ Inches
 _____ mm
 Tube Material: _____

Trace Tube:

Size: (O.D. and wall thickness): _____ Inches
 _____ mm
 Tube Material: _____

Outer Jacket Type: (Note: Black FR-PVC is Standard)

FR-PVC TPR
 FR-TPE FRPE
 FR-PUR LDPE
 PUR PVDF

Area Classification

General Purpose
 Class 1, Division 2
 Class 1, Division 1

Approval Agency

FM CSA ATEX



WARNING

This product can expose you to chemicals including Antimony Oxide (Antimony Trioxide), which is known to the State of California to cause cancer. For more information go to www.P65Warnings.ca.gov.

Analyzer Bundles for Process Monitoring and Probe Control

General Heated Bundle Design

Heated CEMS products normally consist of two sections within the umbilical: the heated core and the unheated probe support section.

In some cases, customers will choose to have these two sections broken down into separate umbilicals; however, to reduce installation cost and time, all components can be included in one control umbilical.

Heated Core:

Typically, the heated core consists of two or three tubes: sample tubes, calibration tubes and possibly a spare. These tubes can be color coded for ease of identification.

Within the heated core, a heating element will be positioned to ensure the most consistent and uniform heat transfer between all lines. The product can also be designed to include a temperature sensor device. The most common devices used are 100 Ohm RTD's or Thermocouples.

Temperature sensors are placed at points along the heated core that allow for uniform heat control under various ambient and process conditions.

Unheated Core Probe Support Section:

The unheated section of the umbilical is at a temperature interface outside the heated core that allows for placement of probe support wires and unheated air lines and calibration lines.

Electrical probe support wires and fiber-optic cables can be included within the unheated area to offer a completed assembly.

Products are designed to customer application specifications and can include any number and combination of tubing materials and electrical wire controls.

We have outlined a special design questionnaire specifically tailored to assist you with designing a product that will meet your needs. (See Page 57)

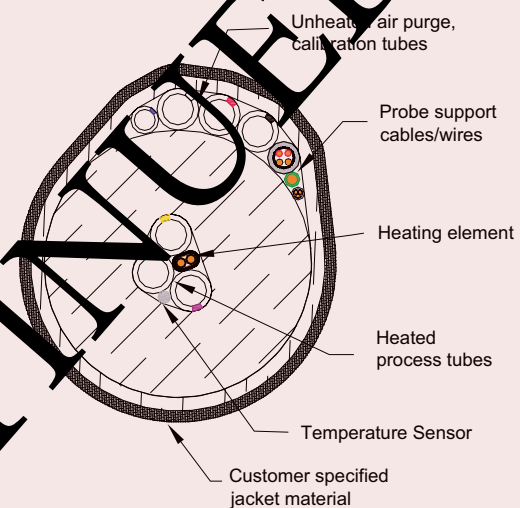

General Probe Support Bundle Design

Parflex Division is also a leading manufacturer of probe support umbilicals. These multitube bundles are made to the customer's design requirements, with unheated tubes, electrical wires, and probe temperature sensor wires, such as thermocouple extension cables.

Probe support umbilicals can consist of any combination of tubes and sizes. The tubes will be uniquely identified for quick and accurate field connection. In many cases, probe support bundles will not see extreme heat, therefore more economical electrical wire material can be used, such as THHN cables or conductors.

Any of Parflex Division's umbilicals can be jacketed with the customer's specified material, including FR-TPE, FR-PVC and Urethane materials. (See the technical data section for jacket selection)

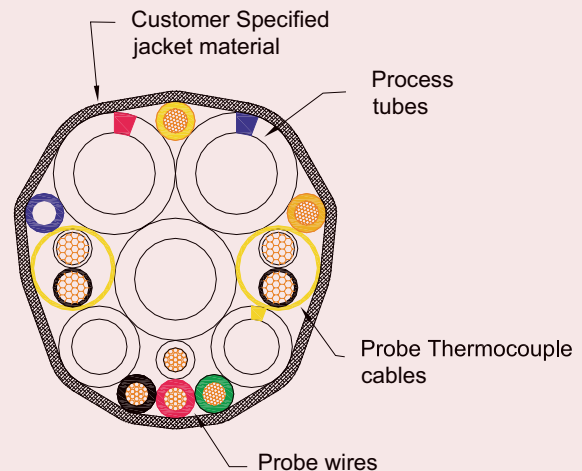

Analyzer & Process Control Umbilical Design Form

Individual Run Length:		Total Quantity Required:
_____ft	_____ft	_____ft

- Application (Check)
- Non-Heated:
- Freeze Protection: (Default: Maintain 40°F at -40°F)
- Temperature Maintenance:

- 1) If heated, what temperature is to be maintained within heated core? _____ °F °C
- 2) What is the minimum ambient temperature? _____ °F °C
- 3) What is the maximum exposure temperature of the heated core? _____ °F °C
- 4) What operating voltage is being used? _____
- 5) What breaker size is being used? _____
- 6) Do you have a heater preference? (SR, Constant Watt, VPL or MI) _____
If not, Parker can recommend a heater based upon design criteria.
- 7) Area Classification: Ordinary C1D2 Zone 2 Required _____
- 8) Approval Agency: FM CSA CE ATEX

Heated Tube -- Core Questions

- 1) Provide the number of **heated** tubes, size and material required.
 Number of Tubes: _____ Size _____ Material _____ Colors _____
 Number of Tubes: _____ Size _____ Material _____ Colors _____
 Number of Tubes: _____ Size _____ Material _____ Colors _____
- 2) What type sensor do you want in the umbilical? RTD or Thermocouple
 Where is sensor to be positioned? _____ feet from: Analyzer End or Probe End

Unheated Layer -- Material Questions

- 1) What is the maximum exposure temperature of unheated elements? _____ °F °C
- 2) Provide the number of **unheated** tubes, size and material required.
 Number of Tubes: _____ Size _____ Material _____ Colors _____
 Number of Tubes: _____ Size _____ Material _____ Colors _____
 Number of Tubes: _____ Size _____ Material _____ Colors _____
- 3) Do you need probe support or other electrical wires in umbilical?
 Number of Wires: _____ Size _____ Material _____ Colors _____
 Number of Wires: _____ Size _____ Material _____ Colors _____
- 4) What type of outer jacket is requested? (Black FR-PVC is standard) _____



WARNING

This product can expose you to chemicals including Antimony Oxide (Antimony Trioxide), which is known to the State of California to cause cancer. For more information go to www.P65Warnings.ca.gov.

Section 4

Metal and Plastic Multitube® Bundles

**General Design:**

Parflex Division Multitube® Instrumentation tubing bundles are available in a variety of metal and plastic tubing materials.

Bundled tubing is an ideal alternative for applications where multiple lengths of tubing are currently being installed independently. Bundled tubing typically will save space within cabled trays, reduce the overall installation cost and offer protection to the individual tubes while being routed throughout a plant.

Multitube® bundles can be manufactured with or without protective, galvanized steel armor and a protective outer jacket.

Galvanized steel armor offers supreme mechanical protection for the tubes in areas of the plant where crush resistance is needed, as well as for direct burial applications.

Tubing Identification:

Plastic and metal tubes are uniquely identified using a number code printed along the entire length of each tube. Each tube is uniquely numbered, making connections fast and accurate during installation.

Color-coding of tubes is also available upon special request.

Jacket Material:

Our standard jacketing material is a black, 105°C-rated, flame-resistant PVC. FR-PVC offers tough protection against corrosive environments, water, oils, acids and alkaline chemicals. Other jacketing materials are available upon request.

Testing:

Each tube in every length of bundle is pressure tested prior to shipment.

Metal tubes are pressure tested using dry N2 at 250psi for 5 minutes prior to shipment.

Plastic tubes are pressure tested using dry N2 at 125psi for 5 minutes.

Other testing and third party certifications are available upon request. Including ABS (American Bureau of Shipbuilding), DNV (Det Norske Veritas) and Lloyds. Contact the factory for details.

How to Specify & Order Metal Tubing Bundles

4 MJ - 1 04 30 - U B

4	No. of Tubes	MJ	Product Design	1	Tube Material
1 = 1 Tube 2 = 2 Tube 3 = 3 Tube 4 = 4 Tube Etc...		MJ	MJ = Metal, Jacketed MA = Metal, Armored MAJ = Metal, Armor, Jacketed MJR = Metal, Jacketed, Round Cross-Section	1	1= Smls Copper Type DHP Alloy No 122. ASTM B68-B75 2= Welded Stainless Steel Type 316/316L ASTM A269 3= Welded Stainless Steel Type 304 ASTM A269 B= Smls 316/316L ASTM A269 C= Smls 304 ASTM A269 D= Monel Type 400 E= Hastelloy C22 H= Smls 316H ASTM A213 M= Smls 316/316L ASTM A213 9= Customer Specified Tube Material All metal tubes are number coded along the length of the tube for identification

04	Tube Size (O.D.)	30	Tube Size (Wall Thickness)	U	Jacket Material	B	Jacket Color
02= 1/8" 03= 3/16" 04= 1/4" 05= 5/16" 06= 3/8" 07= 7/16" 08= 1/2" 10= 5/8" 12= 3/4" 16= 1		30	16=.016" 20=.020" 28=.028" 30=.030 31=.031" 32=.032" 35=.035" 40=.040" 47=.047" 49=.049" 50=.050" 62=.062" 65=.065" 83=.083"	U	V = FR-PVC T = FR-TPE U = FR-PUR P = PUR R = TPR E = FRPE L = LDPE K = PVDF Note: Parflex standard jacket material is FR-PVC For standard FR-PVC black, the -VN may be dropped	B	N = Black B = Blue G = Green O = Orange Y = Yellow P = Purple R = Red W = White Note: Parflex standard jacket color is black
Metric		Metric	89=.89mm 10=1.0mm 15=1.5mm 20=2.0mm 25=2.5mm				
MA = 2mm MB = 4mm MC = 6mm MD = 8mm ME = 10mm MF = 12mm							



WARNING

This product can expose you to chemicals including Antimony Oxide (Antimony Trioxide), which is known to the State of California to cause cancer. For more information go to www.P65Warnings.ca.gov.

Pressure Ratings-Metal Tubes*

Tubing Type	Tube Size (in.)		Tubing Pressure Rating (PSI) Versus Temperature											
			100°F		200°F		300°F		400°F		500°F		600°F	
	O.D.	Wall	Burst	Opr.	Burst	Opr.	Burst	Opr.	Burst	Opr.	Burst	Opr.	Burst	Opr.
Copper Type DHP, Alloy No. 122, Soft Annealed Bright Seamless ASTM B68 and B75	1/4	.030	7230	1450	6630	1330	5730	1150	3620	730	-	-	-	-
	3/8	.032	5040	1010	4620	930	3990	800	2520	510	-	-	-	-
	1/2	.035	4050	810	3710	750	3200	640	2020	410	-	-	-	-
	1/2	.049	5900	1180	5400	1080	4700	940	2950	590	-	-	-	-
Stainless Steel, Type 316 Welded per ASTM A-269	1/4	.035	20100	5025	20100	5025	18200	4550	16900	4225	16300	4075	15900	3975
	3/8	.035	12800	3200	12800	3200	11600	2900	10800	2700	10400	2600	10200	2550
	1/2	.035	9400	2350	9400	2350	8500	2125	7900	1975	7600	1900	7500	1875
	1/2	.049	13500	3375	13500	3375	12300	3075	11400	2850	10900	2725	10700	2675
Stainless Steel, Type 316 Seamless per ASTM A-269	1/4	.035	23650	5910	23645	5910	23300	5825	19880	4970	19180	4795	18700	4675
	3/8	.035	15060	3765	15060	3765	13640	3410	12700	3175	12240	3060	12000	3000
	1/2	.035	11060	2765	11060	2765	10000	2500	9300	2325	8940	2235	8820	2205
	1/2	.049	15880	3970	15880	3970	14480	3620	13420	3355	12820	3205	12580	3145



*All values are nominal, Pressure data is taken from American National Standards Code: ANSI B31.1 B30-1993A Edition

Single Metal Tubing Jacketed

Product Series	Description	Part Number	Nominal Product O.D. (in.)	Standard Length (ft.)	Type of Package	Shipping Weight (lbs./100 ft.)	Minimum Bend Radius (in.)	Product Weight (lbs./100 ft.)
MJ - Metal Tube Jacketed	Copper Tubes: 1/4" O.D. x 0.030" Wall	1MJ-10430-50	0.32	50	Coil	5.4	2	9.7
		1MJ-10430-100		100	Coil	10.3		
		1MJ-10430-500		500	Coil	10.0		
		1MJ-10430-1000		1000	Coil	10.0		
	3/8" O.D. x 0.032" Wall	1MJ-10632-50	0.44	50	Coil	5.8	3	15.8
		1MJ-10632-100		100	Coil	16.8		
		1MJ-10632-500		500	Coil	16.3		
	1/2" O.D. x 0.035" Wall	1MJ-10835-50	0.57	50	Coil	6.3	4	23.0
		1MJ-10835-100		100	Coil	24.5		
		1MJ-10835-500		500	Reel	23.9		
		1MJ-10835-1000		1000	Reel	25.1		
	Welded Stainless Steel Tube 1/4" O.D. x 0.035" Wall	1MJ-20435-50	0.32	50	Coil	5.4	2	19.9
1MJ-20435-100		100		Coil	20.4			
1MJ-20435-500		500		Coil	20.2			
1MJ-20435-1000		1000		Coil	20.1			
3/8" O.D. x 0.035" Wall	1MJ-20635-50	0.44	50	Coil	5.8	3	24.5	
	1MJ-20635-100		100	Coil	25.4			
	1MJ-20635-500		500	Coil	24.9			
	1MJ-20635-1000		1000	Reel	24.9			
1/2" O.D. x 0.035" Wall	1MJ-20835-50	0.57	50	Coil	6.3	7	53.4	
	1MJ-20835-100		100	Coil	54.8			
	1MJ-20835-500		500	Reel	54.3			
	1MJ-0835-1000		1000	Reel	55.4			

WARNING This product can expose you to chemicals including Antimony Oxide (Antimony Trioxide), which is known to the State of California to cause cancer. For more information go to www.P65Warnings.ca.gov.

Multiple Metal Tube Bundles

Product Series	Description	Part Number	Nominal Product O.D. (in.)	Jacket Thickness (in.)	Maximum Pulling Tension (lbs.)	Product Weight (lbs./100 ft.)	Minimum Bend Radius (in.)	Horizontal/ Vertical Support Centers (ft.)	
 <p>MJ - Metal Tube Jacketed</p>	Copper Tubes:	2MJ-10430	.64	.063	300	25	2.5	8	
		4MJ-10430	.74	.063	600	43	2.5	8	
	1/4" O.D. x 0.030" Wall	7MJ-10430	.89	.063	1050	70	3.5	12	
		8MJ-10430	.97	.063	1200	81	3.5	12	
		10MJ-10430	1.15	.063	1500	98	5.0	12	
		2MJ-10632	.89	.063	500	40	5.5	8	
	3/8" O.D. x 0.032" Wall	4MJ-10632	1.05	.063	1000	70	6.5	8	
		2MJ-10835	1.15	.063	700	58	10.0	8	
	1/2" O.D. x 0.035" Wall	3MJ-10835	1.26	.080	1050	84	11.0	8	
		4MJ-10835	1.36	.080	1400	106	12.0	8	
		Welded Stainless Steel Tubes:	2MJ-20435	0.64	.063	500	23.2	3.8	8
	1/4" O.D. x .035" Wall	3MJ-20435	0.68	.063	750	31.8	4.0	8	
		4MJ-20435	0.74	.063	1000	40.4	4.2	8	
		5MJ-20435	0.82	.063	1250	49.5	4.5	8	
7MJ-20435		0.89	.063	1750	66.5	5.3	12		
8MJ-20435		0.97	.063	2000	75.6	6.0	12		
10MJ-20435		1.15	.063	2500	93.9	7.5	12		
12MJ-20435	1.22	.080	3000	110.8	9.0	12			
 <p>MA - Metal Tube Armored</p>	Copper Tubes:	1MA-10430	.49	Not Applicable	150	23	2.5	8	
		2MA-10430	.74		300	44	2.5	8	
		4MA-10430	.84		600	66	2.5	8	
		7MA-10430	.99		1050	97	3.5	12	
		8MA-10430	1.07		1200	111	3.5	12	
		10MA-10430	1.25		1500	134	5.0	12	
	3/8" O.D. x .032" Wall	1MA-10632	.61		250	33	5.5	8	
		2MA-10632	.99		500	66	5.5	8	
		4MA-10632	1.15		1000	102	6.5	8	
		7MA-10632	1.37		1750	153	8.5	12	
		8MA-10632	1.49		2000	177	9.0	12	
		10MA-10632	1.75		2500	212	12.0	12	
	Welded Stainless Steel Tubes	1MA-20435	.49		250	22.7	6.0	8	
		2MA-20435	.74		500	40.7	5.2	8	
		4MA-20435	.84		1000	61.1	5.9	8	
	1/4" O.D. x .035" Wall	7MA-20435	.99		1750	91.9	7.0	12	
		8MA-20435	1.07		2000	103.5	7.5	12	
		10MA-20435	1.25		2500	127.5	8.8	12	
 <p>MAJ - Metal Tube Armored & Jacketed</p>		Copper Tubes:	1MAJ-10430	.56	.063	150	25	6.8	8
			2MAJ-10430	.87	.063	300	55	2.5	8
			4MAJ-10430	.97	.063	600	78	2.5	8
	7MAJ-10430		1.12	.063	1050	111	3.5	12	
	8MAJ-10430		1.20	.063	1200	126	3.5	12	
	10MAJ-10430		1.37	.063	1500	151	5.0	12	
	3/8" O.D. x .032" Wall	1MAJ-10632	.67	.063	250	35.9	8.0	8	
		2MAJ-10632	1.12	.063	500	81	5.5	8	
		4MAJ-10632	1.28	.063	1000	119	6.5	8	
		7MAJ-10632	1.53	.078	1750	179	8.5	12	
		8MAJ-10632	1.65	.078	2000	202	9.0	12	
		10MAJ-10632	1.91	.078	2500	244	12.0	12	
Welded Stainless Steel Tubes	1MAJ-20435	.56	.032	250	25.2	6.8	8		
	2MAJ-20435	.87	.063	500	50.4	5.2	8		
	4MAJ-20435	.97	.063	1000	72.0	5.9	8		
	7MAJ-20435	1.12	.063	1750	104.7	7.0	12		
	8MAJ-20435	1.20	.063	2000	117.0	7.5	12		
	10MAJ-20435	1.37	.063	2500	143.5	8.8	12		

WARNING This product can expose you to chemicals including Antimony Oxide (Antimony Trioxide), which is known to the State of California to cause cancer. For more information go to www.P65Warnings.ca.gov.

How to Specify & Order Plastic Tubing Bundles

4 PJ - E 04 40 - U B

4	No. of Tubes	PJ	Product Design	E	Tube Material
	1 = 1 Tube 2 = 2 Tube 3 = 3 Tube 4 = 4 Tube Etc...		PJ = Polymer, Jacketed PA = Polymer, Armored PAJ = Polymer, Armor, Jacketed PJH = Polymer, Jacketed Heavy 3/16"		E = Polyethylene H = High Density Polyethylene R = FR-PE N = Nylon U = Urethane P = PFA Fluoropolymer F = FEP Fluoropolymer T = TFE Fluoropolymer 9 = Customer Specified Tube Material. All Tubes are black and number coded, except Fluoropolymer tubes which are all natural. Colored tubes are available upon special request

04	Tube Size (O.D.)	40	Tube Size (Wall Thickness)	U	Jacket Material	B	Jacket Color
	02= 1/8" 03= 3/16" 04= 1/4" 05= 5/16" 06 = 3/8" 07 = 7/16" 08 = 1/2" 10 = 5/8" 12 = 3/4" 16 = 1"		16=.016" 20=.020" 28=.028" 30=.030 31=.031" 32=.032" 35=.035" 40=.040" 47=.047" 49=.049" 50=.050" 62=.062" 65=.065" 83=.083"		V = FR-PVC T = FR-TPE U = FR-PUR P = PUR R = TPR E = FRPE L = LDPE K = PVDF		N = Black B = Blue G = Green O = Orange Y = Yellow P = Purple R = Red W = White
	Metric		Metric		Note: Parflex standard jacket material is FR-PVC For standard FR-PVC black, the -VN may be dropped		Note: Parflex standard jacket color is black For standard FR-PPVC black-VN may be dropped
	MA = 2mm MB = 4mm MC = 6mm MD = 8mm ME = 10mm MF = 12mm		89=.89mm 10=1.0mm 15=1.5mm 20=2.0mm 25=2.5mm				





WARNING

This product can expose you to chemicals including Antimony Oxide (Antimony Trioxide), which is known to the State of California to cause cancer, and Ethylene Oxide, which is known to the State of California to cause birth defects or other reproductive harm. For more information go to www.P65Warnings.ca.gov.

Multiple Plastic Tube Bundles

Product Series	Description	Part Number	Number of Tubes	Jacket Thickness (in.)	Nominal Product O.D. (in.)	Minimum Bend Radius (in.)	Maximum Pulling Tension (lbs.)	Product Weight (lbs./100 ft.)
PJ - Plastic Tube Jacketed 	Polyethylene Tubes: 1/4" O.D. x .040" Wall	2PJ-E0440	2	.045	.59	1.5	90	8.6
		3PJ-E0440	3	.045	.60	1.5	110	11.4
		4PJ-E0440	4	.063	.74	2.0	140	12.8
		5PJ-E0440	5	.063	.88	2.0	170	15.1
		7PJ-E0440	7	.063	.89	2.5	195	17.5
		8PJ-E0440	8	.063	.97	2.5	235	19.5
		10PJ-E0440	10	.063	1.14	3.0	260	22.8
		12PJ-E0440	12	.063	1.14	3.5	300	25.4
		14PJ-E0440	14	.063	1.25	4.0	340	28.8
		19PJ-E0440	19	.080	1.40	5.0	425	36.8
	37PJ-E0440	37	.080	1.96	9.0	880	74.5	
	Polyethylene Tubes: 3/8" O.D. x .062" Wall	2PJ-E0662	2	.063	.89	2.0	160	13.9
		3PJ-E0662	3	.063	.89	2.0	195	17.9
		4PJ-E0662	4	.063	1.05	2.5	265	21.1
		5PJ-E0662	5	.063	1.16	3.0	295	24.6
		7PJ-E0662	7	.080	1.31	4.0	365	29.7
		10PJ-E0662	10	.080	1.72	5.0	515	44.2
		12PJ-E0662	12	.080	1.80	6.0	685	60.8
		19PJ-E0662	19	.080	2.13	10.0	900	85.5

Product Series	Description	Part Number	Number of Tubes	Nominal Product O.D. (in.)	Minimum Bend Radius (in.)	Maximum Pulling Tension (lbs.)	Product Weight (lbs./100 ft.)	Horizontal/Vertical Support Centers		
PA - Plastic Tube Armored 	Polyethylene Tubes: 1/4" O.D. x .040" Wall	2PA-E0440	2	.74	2.5	90	29	4		
		3PA-E0440	3	.78	2.5	110	32	4		
		7PA-E0440	7	.99	3.5	195	45	6		
		10PA-E0440	10	1.25	5.0	260	60	6		
		12PA-E0440	12	1.28	6.0	300	67	6		
		19PA-E0440	19	1.50	8.0	425	84	6		
		37PA-E0440	37	2.00	11.0	880	127	6		
	Polyethylene Tubes: 3/8" O.D. x .062" Wall	2PA-E0662	2	.99	5.5	160	43	4		
		3PA-E0662	3	1.05	6.0	195	48	4		
		10PA-E0662	10	1.75	12.0	515	101	6		
		12PA-E0662	12	1.81	12.5	685	109	6		
		19PA-E0662	19	2.13	15.0	900	141	6		
		PAJ - Plastic Tube Armored and Jacketed 	Polyethylene Tubes: 1/4" O.D. x .040" Wall	2PAJ-E0440	2	.87	2.5	90	39	4
				3PAJ-E0440	3	.90	2.5	110	42	4
7PAJ-E0440	7			1.12	3.5	195	58	6		
10PAJ-E0440	10			1.37	5.0	260	76	6		
12PAJ-E0440	12			1.44	6.0	300	88	6		
19PAJ-E0440	19			1.65	8.0	425	108	6		
Polyethylene Tubes: 3/8" O.D. x .062" Wall	37PAJ-E0440	37	2.16	11.0	880	159	6			
	2PAJ-E0662	2	1.12	5.5	160	56	4			
	3PAJ-E0662	3	1.18	6.0	195	62	4			
	10PAJ-E0662	7	1.53	8.5	365	98	6			
	12PAJ-E0662	10	1.91	12.0	515	129	6			
	19PAJ-E0662	12	1.96	12.5	685	138	6			

WARNING
 This product can expose you to chemicals including Antimony Oxide (Antimony Trioxide), which is known to the State of California to cause cancer, and Ethylene Oxide, which is known to the State of California to cause birth defects or other reproductive harm. For more information go to www.P65Warnings.ca.gov.

Section 5

Parflex Multitube® Instrumentation Tubing Products
Compatibility Chart

Ratings Code:

- G** – Good to excellent. Little or no swelling, tensile or surface changes. Preferred choice.
- L** – Marginal or conditional. Noticeable effects but not necessarily indicating lack of serviceability. Further testing suggested for specific application. Very long-term effects such as stiffening or potential for crazing should be evaluated.
- P** – Poor or unsatisfactory. Not recommended without extensive and realistic testing.
- – Indicates that this was not tested.

Materials Code for Parflex Multitube® Instrumentation Tubing Products

- E** Low Density Polyethylene
- HDPE** High Density Polyethylene
- N** Polymeric Flexible Nylon
- FRPE** Flame Resistant Polyethylene

Chemical	LDPE	HDPE	N	FRPE
Acetone	P	L	G	L
Acetyl Bromide	L	L	P	-
Acetyl Chloride	L	L	P	-
Air	G	G	G	G
Alcohols	G	G	G	G
Aluminum Salts	G	G	G	G
Ammonia	G	G	G	L
Amyl Acetate	G	G	G	-
Aniline	L	G	P	-
Animal Oils (3)	P	L	G	-
Arsenic Salts	G	G	G	G
Aromatic Hydrocarbons	P	L	G	P
Barium Salts	G	G	G	G
Benzaldehyde	P	L	L	P
Benzene	P	L	G	P
Benzyl Alcohol	P	G	L	P
Bleaching Liquors	G	L	L	-
Boric Acid Solutions	G	G	G	G
Bromine	L	L	P	-
Butane (1)	L	G	G	-
Butanol	G	G	G	G
Butyl Acetate	G	G	G	G
Calcium Hypochlorite	L	L	P	L
Calcium Salts	G	G	G	G
Carbon Dioxide	G	G	G	G
Carbon Disulfide	L	L	L	-
Carbon Tetrachloride	P	P	L	P
Caustic Potash	G	G	G	-
Caustic Soda	G	G	G	-
Chloroacetic Acid	L	G	L	-
Chlorine (Dry)	L	L	P	-
Chlorine (Wet)	L	L	P	-
Chlorobenzene				
Chloroform	P	L	P	P
Chromic Acid	L	L	P	-
Copper Salts	G	G	G	G
Cresol	P	L	P	P
Cyclohexanone	L	L	L	-
Ethers	L	L	G	-
Ethyl Acetate	G	G	G	-
Ethyl Alcohol	G	G	L	G
Ethylamine	L	G	L	-
Ethyl Bromide	P	L	L	P
Ethyl Chloride	P	L	L	P
Fatty Acids	L	L	G	P
Ferric Salts	G	G	G	-
Formaldehyde	G	G	L	-
Formic Acid	G	G	P	G
Freon	L	L	G	-
Gasoline (1)	P	G	G	P
Glucose	G	G	G	G

Chemical	LDPE	HDPE	N	FRPE
Glycerin	G	G	G	G
Hydriodic Acid	L	G	P	-
Hydrochloric Acid. (Conc.)	L	G	L	-
Hydrochloric Acid. (Med. Conc.)	L	G	L	-
Hydrofluoric Acid	L	L	P	-
Hydrogen Peroxide (Conc)	L	G	L	-
Hydrogen Peroxide (Dil.)	L	G	G	-
Hydrogen Sulfide	G	G	G	-
Iodine	L	G	G	-
Kerosene (1)	L	L	G	-
Ketones	G	G	G	-
Lacquer Solvents	L	L	G	-
Lactic Acid	G	G	G	-
lead Acetate	G	G	G	-
Linseed Oil	L	G	G	-
Magnesium Salts	G	G	G	-
Naphtha	L	L	G	G
Natural Gas	L	L	G	-
Nickel Salts	G	G	G	-
Nitric Acid (Conc.)	P	L	P	G
Nitric Acid (Dil.)	P	G	L	P
Nitrobenzene	P	L	L	P
Nitrogen Oxides	L	L	L	-
Nitrous Acid	L	L	L	-
Oils (Animal and Mineral)	L	L	G	-
Oils (Vegetable)	L	L	G	-
Oxygen (2) (3)	G	G	G	G
Perchloric Acid	P	G	P	P
Phenols	P	G	P	P
Potassium Salts	G	G	G	G
Pyridine	L	L	L	-
Silver Nitrate	G	G	G	G
Soap Solutions	G	G	G	G
Sodium Salts	G	G	G	G
Stearic Acid	L	L	G	-
Sulfur Chloride	L	L	L	-
Sulfuric Acid (Conc.)	P	G	P	P
Sulfuric Acid (Dil.)	P	G	L	P
Sulfurous Acid	P	G	L	P
Tannic Acid	G	G	G	-
Tanning Extracts	G	G	G	-
Titanium Salts	G	G	G	G
Toluene	P	L	G	P
Trichloroacetic Acid	L	L	P	-
Trichloroethylene	P	L	L	P
Turpentine	P	P	G	-
Urea	G	G	G	-
Uric Acid	G	G	G	-
Water (3)	G	G	G	G
Xylene	P	L	G	P
Zinc Chloride	G	G	G	-

Footnotes for Fluid Compatibility Guides: The Fluid Compatibility Guides are simplified rating tabulations based on immersion tests at 75° F. Higher temperatures tend to reduce ratings. **Since final selection depends on pressure, fluid and ambient temperature and other factors not known to Parker Hannifin Co., no performance guarantee is expressed or implied.** Ratings do not imply compliance with specialized codes such as FDA, NSF, AGA or UL and do not cover possible fluid discoloration, taste or odor effects. For conveying foodstuffs use FDA sanctioned materials, and for potable water use NSF listed materials. For chemicals not listed, or for advice on particular applications, please consult Product Engineering, Parflex Div., Ravenna, Ohio. (1) Applications for these fluids must take into account legal and insurance regulations. This **does not** imply AGA or UL compliance. (2) Chemical compatibility does not imply low permeation rates. Consult the Parker factory for a recommendation for your specific requirement. (3) Does not imply NSF or FDA compliance.

Polyethylene Tubing

Series E: Instrument Grade—FDA, NSF Listed

Series EB: Ultraviolet Light Resistant

- Chemical Resistant
- Flexible
- Choice of Reel Lengths
- Low Cost
- Five Tube Sizes
- Ten Colors

Parflex Division flexible polyethylene thermoplastic tubing is extruded from high molecular weight resin for increased dimensional stability, uniformity and long-term strength. Its resistance to environmental stress cracking greatly exceeds that of ordinary polyethylene tubing as measured by ASTM D-1693 (10% IGEPAL).

Parflex E series polyethylene tubing is available in black, as well as nine coding colors, as recommended by the Instrument Society of America. Black (EB) tubing contains an ultraviolet inhibitor which is recommended for use in sunlit areas and in close proximity to high ultraviolet light sources. Ingredients of E series natural and colored tubing (except EB series) meet FDA and NSF 51/61 requirements for food contact applications. Black polyethylene FDA and NSF 51/61 tubing is available upon special request. All tubing conforms to ASTM D-1248, Type I, Class A, Category 4, Grade E5. Suggested operating temperature range is -80°F (-62°C) to +150°F (+66°C).

Polyethylene Tubing (cont)

Series FRPE: Flame-Resistant

Flame-resistant polyethylene is manufactured from a distinctively formulated compound which meets the UL94 V-2 flame classification. It also meets the flame spread, fuel contribution and smoke density requirements of the ASTM E84-81a tunnel test. Parflex Series FRPE tubing is the preferred product for pneumatic control applications in the heating, ventilating, air conditioning, energy conservation industry. It is also suitable for use in petrochemical plants, petroleum refineries, pulp and paper mills, mines, steel mills and other industries where protection against intermittent flame and hot sparks is necessary.

Suggested operating temperature range is -85°F (-65°C) to +150°F (+66°C).

Series HDPE: High Density

Parflex Division Series HDPE is manufactured from high strength, high density polyethylene. This semirigid tubing is inherently resistant to most chemicals, less easily cut or damaged and has a higher burst pressure rating than series E tubing. Suggested operating temperature range is -80°F (-62°C) to +175°F (+80°C).

Nylon Tubing

Series N: Flexible

Parflex Division flexible nylon tubing is carefully made from high-grade, abrasion resistant, heat and light stabilized nylon. Resistance to stress cracking greatly exceeds that of ordinary nylon tubing. Parflex nylon also exhibits extremely low level water absorption.

Chemical-resistant Parflex nylon tubing has the additional benefits of better flexibility, lighter weight and resistance to flexural fatigue. NN and NB tubing meets UL94HB flame resistance ratings in wall thicknesses of .033" and greater. Operating temperatures, depending upon conditions, are -65°F (-54°C) to +200°F (+93°C) continuous.

Available in natural (NN), red (RED), green (GRN), blue (BLU), yellow (YEL), and black (NB). Black tubing is recommended for use outdoors and in sunlit areas.

Burst Pressure/Temperature Charts

Polyethylene Tubing

Laboratory Grade E Series
1/4 through 5/8 O. D. inches

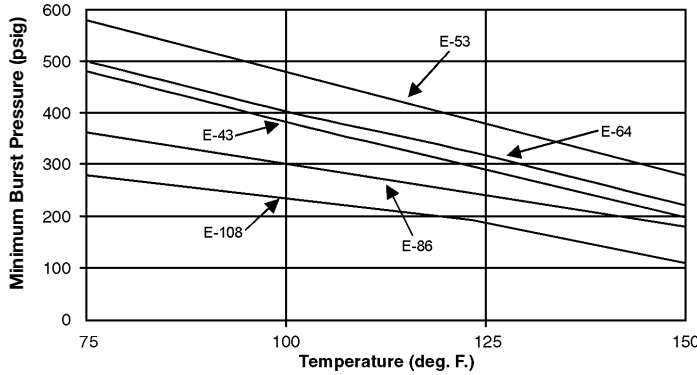

Nylon Flexible Tubing

N Series (NN, NB)
1/8 through 1/2 O. D. inches

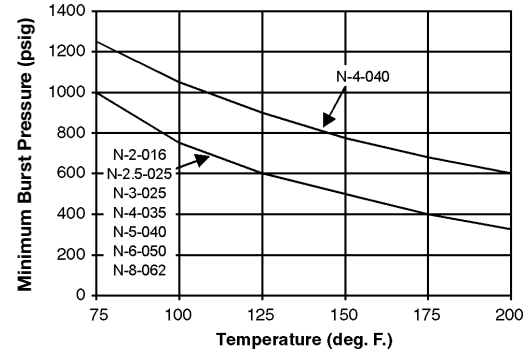

Polyethylene Tubing

High Density HDPE Series
1/4 through 5/8 O. D. inches

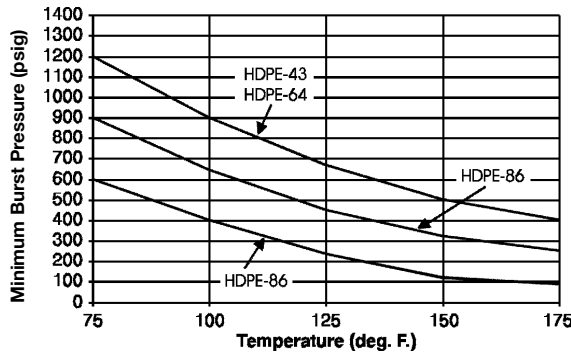

Nylon Flexible Tubing

N Series
1/8 through 1/2 O. D. inches

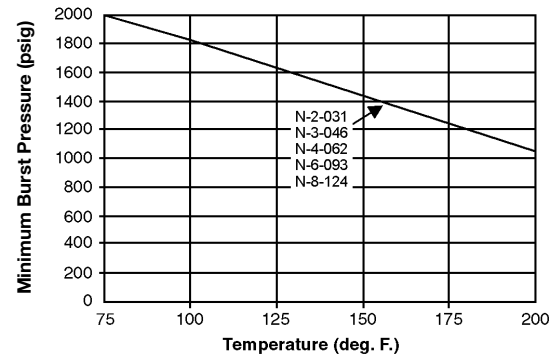

Polyethylene Tubing

Flame Resistant FRPE Series
5/32 through 1/2 O. D. inches

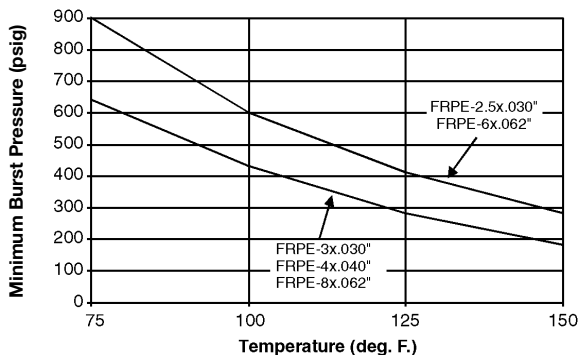

Suggested working pressures of nylon are 1/4 of burst pressure at system operating temperature.

Suggested working pressures of polyethylene are 1/4 of burst pressure at system operating temperature.

Parflex Multitube® Instrumentation Tubing Products Compatibility Chart

Ratings Code:

- G** – Good to excellent. Little or no swelling, tensile or surface changes. Preferred choice.
- L** – Marginal or conditional. Noticeable effects but not necessarily indicating lack of serviceability. Further testing suggested for specific application. Very long-term effects such as stiffening or potential for crazing should be evaluated.
- P** – Poor or unsatisfactory. Not recommended without extensive and realistic testing.
- – Indicates that this was not tested.

Materials Code for Parflex Multitube® Instrumentation Tubing Products

Copper	Copper Type DHP, Alloy No. 122, Soft Annealed Bright Seamless ATM B68 and B75
316SS	Stainless Steel, Type 316 Welded and Seamless per ASTM A-269
Hastelloy	Type C-22 per ASTM 3622 and B626
Monel	Type 400 per ASTM B165

Chemical	Copper	316SS	Hastelloy C	Monel
Acetone	G	G	G	G
Acetylene	P	G	G	G
Acetyl Chloride	P	G	G	L
Air	A	A	A	A
Alcohols	L	G	G	L
Aluminum Salts	-	-	-	-
Ammonia Aqueous	P	G	L	G
Amyl Acetate	P	G	G	G
Aniline	P	L	L	L
Arsenic Acid	L	L	L	P
Barium Carbonate	G	L	L	L
Benzaldehyde	L	L	G	L
Benzene	G	L	L	L
Benzyl Alcohol	-	G	G	G
Bleach 5% Active	-	G	G	G
Boric Acid 5%	L	L	G	L
Bromine Moist Gas	P	P	G	P
Butane (1)	L	G	G	G
Butyl Acetate	G	G	G	G
Calcium Hypochlorite 2% Boiling	P	L	L	L
Calcium Chloride Saturated	P	G	L	L
Carbon Dioxide	L	G	G	G
Carbon Disulfide	P	L	L	L
Carbon Monoxide	L	G	G	G
Caustic Potash	P	P	L	L
Caustic Soda	P	L	L	L
Chloracetic Acid	P	P	L	L
Chlorine (Dry)	P	P	P	P
Chlorine (Wet)	P	P	P	L
Chloroform	L	L	L	L
Chromic Acid Dilute	P	L	G	P
Copper Cyanide	P	L	L	L
Cresol	-	G	L	G
Cyclohexanone	-	G	G	-
Ethers	L	L	L	L
Ethyl Acetate	L	L	G	G
Ethyl Chloride Wet	L	G	L	L
Ethylamine	L	L	L	L
Ethyl Benzene	-	L	G	-
Ethyl Ether	L	L	L	L
Fatty Acids	P	G	G	L
Ferric Sulfate	P	G	L	P
Formaldehyde	L	L	L	L
Formic Acid	P	L	G	P
Freon Dry	G	G	G	L
Gasoline (1)	P	G	G	L
Glucose	G	G	-	G
Glycerin	G	G	G	G

Hydrochloric Acid. (Conc.) 40%	L	L	G	L
Hydrochloric Acid. (Conc.) 50%	L	L	G	L
Hydrofluoric Acid Boiling	P	G	P	L
Hydrogen Peroxide	L	L	G	P
Hydrogen Peroxide (Dil.)	L	G	L	G
Hydrogen Sulfide	L	G	L	L
Iodine	P	P	G	-
Kerosene (1)	G	G	G	G
Ketones	-	L	G	G
Lacquer Solvents	G	G	G	G
Lactic Acid	L	L	L	P
lead Acetate	L	L	L	L
Linseed Oil	L	G	G	G
Magnesium Carbonate	G	G	L	G
Naphtha	L	G	L	G
Natural Gas	G	G	G	G
Nickel Sulfate	P	L	L	L
Nitric Acid	P	L	P	P
Nitric Acid Fuming>10%	P	P	P	P
Nitrobenzene	-	G	L	G
Nitrous Oxide	G	L	L	P
Nitrous Acid	P	L	G	P
Oils Animal	-	G	G	L
Oils Mineral	L	G	G	G
Oils (Vegetable)	L	G	G	G
Oxygen (2) (3)	G	G	G	G
Perchloric Acid	-	P	L	P
Phenols	-	L	G	L
Potassium Acetate	-	L	-	-
Pyridine	L	G	L	G
Silver Nitrate	P	L	L	P
Soap Solutions	L	G	G	G
Sodium Aluminate	-	G	L	L
Stearic Acid	L	G	L	L
Sulfur Chloride	P	P	G	P
Sulfur Dioxide Gas Dry	L	G	L	L
Sulfuris Trioxide	-	L	L	L
Sulfurous Acid	P	P	L	P
Tannic Acid	L	G	L	P
Tanning Liquor (Alum Solution)	-	G	L	-
Titanium Tetrachloride	L	L	L	L
Toluene	G	G	G	G
Trichloroacetic Acid	P	P	G	L
Trichloroethylene	P	L	L	L
Turpentine	L	G	L	L
Urea	-	L	L	-
Uric Acid	G	L	L	L
Water, Distilled	L	G	G	G
Xylene	G	G	G	G
Zinc Chloride	L	P	G	L

Footnotes for Fluid Compatibility Guides: The Fluid Compatibility Guides are simplified rating tabulations based on immersion tests at 75° F. Higher temperatures tend to reduce ratings. **Since final selection depends on pressure, fluid and ambient temperature and other factors not known to Parker Hannifin Co., no performance guarantee is expressed or implied.** Ratings do not imply compliance with specialized codes such as FDA, NSF, AGA or UL and do not cover possible fluid discoloration, taste or odor effects. For conveying foodstuffs use FDA sanctioned materials, and for potable water use NSF listed materials. For chemicals not listed, or for advice on particular applications, please consult Product Engineering, Parflex Div., Ravenna, Ohio. (1) Applications for these fluids must take into account legal and insurance regulations. This **does not** imply AGA or UL compliance. (2) Chemical compatibility does not imply low permeation rates. Consult the Parker factory for a recommendation for your specific requirement. (3) Does not imply NSF or FDA compliance.

Material Specifications for Metal Tubing

Tubing Pressure Rating*

Tubing Type	Tube Size (in.)		Tubing Pressure Rating (PSI) Versus Temperature**											
	O.D.	Wall	100°F		200°F		300°F		400°F		500°F		600°F	
			Burst	Opr.	Burst	Opr.	Burst	Opr.	Burst	Opr.	Burst	Opr.	Burst	Opr.
Copper Type DHP, Alloy No. 122, Soft Annealed Bright Seamless ASTM B68 and B75	1/4	.030	7230	1450	6630	1330	5730	1150	3620	730	-	-	-	-
	3/8	.032	5040	1010	4620	930	3990	800	2520	510	-	-	-	-
	1/2	.035	4050	810	3710	750	3200	640	2020	410	-	-	-	-
	1/2	.049	5900	1180	5400	1080	4700	940	2950	590	-	-	-	-
Stainless Steel, Type 316 Welded per ASTM A-269	1/4	.035	20100	5025	20100	5025	18200	4550	16900	4225	16300	4075	15900	3975
	3/8	.035	12800	3200	12800	3200	11600	2900	10800	2700	10400	2600	10200	2550
	1/2	.035	9400	2350	9400	2350	8500	2125	7900	1975	7600	1900	7500	1875
	1/2	.049	13500	3375	13500	3375	12300	3075	11400	2850	10900	2725	10700	2675
Stainless Steel, Type 316 Seamless per ASTM A-269	1/4	.035	23650	5910	23645	5910	23300	5825	19880	4970	19180	4795	18700	4675
	3/8	.035	15060	3765	15060	3765	13640	3410	12700	3175	12240	3060	12000	3000
	1/2	.035	11060	2765	11060	2765	10000	2500	9300	2325	8940	2235	8820	2205
	1/2	.049	15880	3970	15880	3970	14480	3620	13420	3355	12820	3205	12580	3145

*All values are nominal.
 **Notes regarding pressure data are on the following page.

Reference: Pressure data for metal tubing is taken from American National Standard Code for Pressure Piping, "Power Piping, ANSI B31.1 – B30-1993A Edition." The values stated for operating (opr.) pressure are the maximum internal service pressure determined using the calculated burst pressure and an associated design factor. The equations and stress values were extracted from the above listed document.

Pressure data for Parker stainless steel tubing is derived from the relation shown to the right.

$$\text{Burst Pressure} = K \frac{2st}{D-0.8t}$$

where K = efficiency of weld (0.85);
 (K = 1 for seamless)
 s = tensile strength of stainless steel (psi)
 D = tube O.D., in inches
 t = tube wall thickness in inches

The operating pressure is taken to be 25% of the burst pressure, which is a 4 to 1 design factor.

Notes:

Copper and Stainless Tube

**Pressure data for temperatures above 200°F are included for reference only.

Plastic coated tubing should not be used at temperatures exceeding approximately 80°C due to the PVC (or PE) jacket employed.

Copper - Armored Tubing

**Pressure data for temperatures above 200°F are included primarily for where the tubing must withstand higher ambient temperatures.

The assembly should not be used at temperatures exceeding approximately 80°C (176°F) due to the PVC tapes and jackets employed. Consult the Division if higher temperatures will be encountered.

Copper - Jacketed Tubing

**Pressure data for temperatures above 200°F are included primarily for where single runs must withstand higher ambient temperatures than the Multitube® bundle.

The Multitube® bundle should not be used at temperatures exceeding approximately 105°C due to the PVC jacket employed. Consult the Division if higher temperatures will be encountered.

Stainless Steel - Jacketed Tubing

**Pressure data for temperatures above 200°F are included primarily for where single runs must withstand higher ambient temperatures than the Multitube® bundle.

The Multitube® bundle should not be used at temperatures exceeding approximately 105°C due to the PVC jacket employed. Consult the Division if higher temperatures will be encountered.

Testing Specifications for Metal Tubing:

All metal tubes used in the manufacture of Multitube® bundles are subject to stringent magnetic analysis using a special eddy current tester. Each tube, after eddy current analysis, is pressure tested at not less than 250 psi for 15 minutes without any sign of leakage.

When Multitube® assemblies have completed the manufacturing process, each tube is tested again with dry N₂ at 250 psi for 5 minutes prior to shipment.

Testing Specifications for Plastic Tubing:

All plastic used in the manufacture of Multitube® bundles are subject to rigorous Q.A. inspection and testing prior to shipment. Each tube is pressure tested at not less than 150 psi for 15 minutes without any sign of leakage.

When Multitube® assemblies have completed the manufacturing process, each tube is tested again with dry N₂ at 125 psi for 5 minutes prior to shipment.

Material Specifications for Jackets:

Flame-Resistant Polyvinyl Chloride (FR PVC)

Jacket: Black, 105°C-rated, flame-resistant, corrosion-resistant thermoplastic compound with excellent low-temperature flexibility properties. Meets or exceeds ASTM D-1047, IPCEA S-19-81, and IPCEA S-61-401.

Thermoplastic Rubber (TPR) Jacket: Black, corrosion- and weather-resistant thermoplastic rubber material.

Flame-Resistant Thermoplastic Elastomer

(FR-TPE) Jacket: Black, flame-retarding thermoplastic elastomer compound. UL94-V-0 flame classification. Passes IEEE vertical flame test. Meets ASTM D-2671 copper mirror corrosion test standards.

Polyurethane (PUR) Jacket: Black, abrasion- and corrosion-resistant compound with excellent hydrolytic stability.

Flame-Resistant Polyurethane (FR PUR) Jacket: Black, flame-retarding, abrasion- and corrosion-resistant compound which exhibits excellent low-temperature properties, hydrolysis resistance, and fungus resistance which has a UL94 flame test rating of V-0.

Low Density Polyethylene (LDPE) Jacket: Black, weather-resistant grade, high molecular weight, low-density compound which meets the requirements of ASTM D-1248-72 as follows: Type I, Class A, Category 4, Grade E5.

Flame-Resistant Polyethylene (FRPE) Jacket: Black, weather-resistant, high molecular weight, flame-resistant polyethylene compound which meets the UL94 V-2 flame classification.

Selecting a Jacket Material

Parflex Multitube® Instrument and Heat Trace Tubing Products are currently offered with a choice of several jacket materials. The purpose of this report is to present the main properties of the standard thermoplastics and to discuss selection factors for various Multitube® products.

The following table provides a summary of the main properties of the standard jacket materials. Additional details can be provided upon request to the factory.

Current Jacket Materials for Multitube® Products

	105°C FR-PVC	TPR	FR-TPE	PUR	FR-PUR	LDPE	FRPE
Hardness, Shore A	72	92	87	90	75	50D	90
Abrasion resistance	G	G	G	E	E	G	G
Mechanical resistance	G	F	G	E	E	G	G
Max. continuous service °F	221	248	266	250	180	150	150
Low temp. brittleness °F	-41	-55	-69	-40	-90	-80	-80
Rec. min. installation °F	-35	-50	-60	-20	-70	-50	-60
Environmental Resistance							
Aliphatic hydrocarbons	F	P	G	G	G	G	G
Aromatic hydrocarbons	U	P	F	G	G	G	F
Halogenated solvents	U	P	P	P	P	F-P	P
Acids	F	G	E	F	F	G	G
Alkalies	F	G	E	G	G	G	E
Oils	G	F	E	G	G	E	G
Water	G	E	E	G	G	E	E
Weathering	G*	F*	E*	E*	E*	G*	G*
Flamability							
Oxygen index	24	NFR	24.7	NFR	26	NFR	25
UL94 vertical flame test	V-2	—	V-0	—	V-0	—	V-2
IEEE vertical tray flame test	Pass	—	Pass	—	Pass	—	Pass
Water absorption, 24 hours, %	.1	1.5	.3	1.0	1.5	.01	0.3

E = Excellent G = Good F = Fair P = Poor U = Unsatisfactory NFR = Not flame resistant

Note: Bundles may also be armored with galvanized steel, arch-shaped, spiral wound sheet metal designed for greater crush protection and pull-apart resistance.

Please refer to product bulletins in the Instrument Tubing and Pre-Insulated Tubing section of the Multitube® catalog for data on standard Multitube® products utilizing the jacket materials described in this engineering report.

*Requires carbon black for ultraviolet (U.V.) resistance.

SEAMLESS TUBING MATERIAL PRODUCTION LIST

Corrosion Resistant Alloys	
304	Monel 400
304L	Monel K500
316	Inconel 625
316L	Incoloy 825
317L	C22
347	C276

Heat Resistant Alloys
321
310
Alloy 718

316/L COIL LENGTHS* IMPERIAL SIZE TUBING					
Nominal Outer Diameter	Wall	Coil Length			
(in)	(in)	(ft)	(m)	lbs/ft	kg/m
0.125	0.028	6260	1908	0.030	0.045
0.125	0.035	5370	1636	0.035	0.052
0.250	0.028	2760	841	0.068	0.101
0.250	0.035	2260	688	0.083	0.124
0.250	0.049	1740	530	0.108	0.161
0.375	0.035	1410	429	0.131	0.195
0.375	0.049	1050	320	0.175	0.260
0.375	0.065	830	252	0.221	0.329
0.500	0.035	1010	307	0.178	0.265
0.500	0.049	740	225	0.242	0.360
0.500	0.065	580	176	0.310	0.461
0.625	0.035	790	240	0.226	0.336
0.625	0.049	580	176	0.309	0.460
0.625	0.065	450	137	0.398	0.592
0.750	0.049	470	143	0.376	0.560
0.750	0.065	360	109	0.487	0.725
1.000	0.065	270	82	0.665	0.990
1.000	0.083	210	64	0.832	1.238

316/L COIL LENGTHS* METRIC SIZE TUBING					
Nominal Outer Diameter	Wall	Average Coil Length			
(in)	(in)	(ft)	(m)	lbs/ft	kg/m
6.00	1.00	2230	679	0.084	0.125
6.00	1.50	1630	496	0.115	0.171
8.00	1.00	1590	484	0.118	0.176
8.00	1.50	1130	344	0.166	0.247
10.00	1.00	1210	368	0.152	0.226
10.00	1.50	850	259	0.217	0.323
12.00	1.00	1000	304	0.185	0.275
12.00	1.50	690	210	0.267	0.397
14.00	1.00	820	249	0.219	0.326
14.00	1.50	560	170	0.318	0.473
18.00	1.00	420	128	0.419	0.624
18.00	2.50	270	82	0.654	0.973
20.00	1.25	450	137	0.396	0.589
20.00	1.50	380	115	0.470	0.699

* Contact factory for other alloy coil length packages.

TUBE WORKING, YIELD AND BURST PRESSURE FOR SEAMLESS TUBING
Type 316L at -20° to +100°F (-29°C to 37.8°C)

Imperial Size							
OD (in.)	Wall (in)	Nominal ID (in)	Yield Strength	Tensile Strength	Ratio	Boardmanz Yield	Boardmanz Burst
0.125	0.028	0.069	25,000	70,000	0.224	11991	56812
0.125	0.035	0.055	25,000	70,000	0.280	15202	89091
0.250	0.028	0.194	25,000	70,000	0.112	6204	21445
0.250	0.035	0.180	25,000	70,000	0.140	8540	29519
0.250	0.049	0.152	25,000	70,000	0.196	10355	45132
0.375	0.035	0.305	25,000	70,000	0.093	4872	16839
0.375	0.049	0.277	25,000	70,000	0.131	7710	26652
0.375	0.065	0.245	25,000	70,000	0.173	9039	37143
0.500	0.035	0.430	25,000	70,000	0.070	3408	11779
0.500	0.049	0.402	25,000	70,000	0.098	5190	17940
0.500	0.065	0.370	25,000	70,000	0.130	7653	26454
0.625	0.035	0.555	25,000	70,000	0.056	2621	9058
0.625	0.049	0.527	25,000	70,000	0.078	3912	13520
0.625	0.065	0.495	25,000	70,000	0.104	5614	19403
0.750	0.049	0.652	25,000	70,000	0.065	3139	10848
0.750	0.065	0.620	25,000	70,000	0.087	4432	15320
1.000	0.065	0.870	25,000	70,000	0.065	3120	10782
1.000	0.083	0.834	25,000	70,000	0.083	4198	14511

Metric Size							
OD (mm)	Wall (mm)	Nominal ID (mm)	Yield Strength	Tensile Strength	Ratio	Boardmanz Yield	Boardmanz Burst
6.00	1.00	4.01	25,000	70,000	0.165	11092	38343
6.00	1.50	3.00	25,000	70,000	0.250	13500	70000
8.00	1.00	6.02	25,000	70,000	0.124	7135	24662
8.00	1.50	5.00	25,000	70,000	0.187	9849	41929
10.00	1.00	8.03	25,000	70,000	0.099	5258	18176
10.00	1.50	7.01	25,000	70,000	0.150	9468	32726
12.00	1.00	10.01	25,000	70,000	0.083	4175	14430
12.00	1.50	8.99	25,000	70,000	0.125	7233	25000
14.00	1.00	12.01	25,000	70,000	0.071	3454	11938
14.00	1.50	11.00	25,000	70,000	0.107	5837	20176
18.00	1.00	14.99	25,000	70,000	0.083	4219	14584
18.00	2.50	13.00	25,000	70,000	0.138	8395	29019
20.00	1.25	17.50	25,000	70,000	0.062	2965	10248
20.00	1.50	16.99	25,000	70,000	0.075	3703	12799

For other alloys and temperatures, multiply the pressure shown by the following factor:

Alloy	Temperature			
	Room Temperature	300° F (148°C)	500° F (260°C)	700° F (371°C)
304L	1.00	1.00	0.89	0.81
316L	1.00	1.00	0.86	0.77
Monel 400	1.12	0.92	0.89	—
Inconel 625	2.40	2.40	2.33	2.24
Inconel 825	1.22	1.17	1.04	0.96
C-276	1.50	1.50	1.43	1.38

SEAMLESS TUBE ANALYSES - ASTM STANDARD GRADES AVAILABLE

Analysis	304	304L	316	316L	317L	321	347
Application	General good corrosion resistance grade	Lower carbon of 304 with good weldability	Better corrosion resistance than 304 in chloride	As for 316. Good weldability	As for 316 with increased pitting corrosion resistance	General where good weldability required with possible weld decay attack & improved high temperature properties	As for 321 but uses niobium as stabilizing element
C	.08 Max	.04 Max	.08 Max	.04 Max	.04 Max	.08 Max	.10 Max
Mn	2.00 Max	2.00 Max	2.00 Max	2.00 Max	2.00 Max	2.00 Max	2.00 Max
P	.040 Max	.040 Max	.040 Max	.040 Max	0.04 Max	.040 Max	.040 Max
S	.030 Max	.030 Max	.030 Max	.030 Max	0.03 Max	.030 Max	.030 Max
Si	.75 Max	.75 Max	.75 Max	.75 Max	.75 Max	.75 Max	.75 Max
Cr	18.0/20.0	18.0/20.0	16.0/18.0	16.0/18.0	18.0/20.0	17.0/20.0	17.0/19.0
Ni	8.0/10.5	8.0/12.0	11.0/14.0	10.0/14.0	11.0/15.0	9.0/12.0	9.0/13.0
Other	N: .10 Mo: .50 Max	N: .10 Mo: .50 Max	N: .10 Mo: 2.0/3.0	N: .10 Mo: 2.0/3.0	Mo: 3.0/4.0	N: .10 Ti: 5xC Min 0.70 Max	Cb+Ta: 10xC Min 1.0 Max

Analysis	Monel 400	Monel 500	Alloy 625	Alloy 718	Alloy 825	C276	C22
Application	General purpose alloy with good combination of strength, ductility & corrosion resistance	High strength, precipitation hardenable, good corrosion resistance	Very good resistance to corrosion, pitting crevice & stress corrosion.	Age hardenable, high strength up to 1300F (700C) corrosion resistance & weldability	Good resistance to stress corrosion in sulphuric/ phosphoric acid. Good general resistance.	Very good resistance to chloride sulphuric acid	
C	.30 Max	.25 Max	.10 Max	.08 Max	.05 Max	.01 Max	.015 Max
Mn	2.0 Max	1.5 Max	.50 Max	.35 Max	1.0 Max	1.00 Max	.50 Max
S	.024 Max	.01 Max	.015 Max	.015 Max	.03 Max	.03 Max	.010 Max
Si	.50 Max	.50 Max	.50 Max	.35 Max	.50 Max	.08 Max	.08 Max
Ni+Co	63.0 Max	63.0/70.0	Balance	50.0/55.0	38.0/46.0	Balance	Balance
Cr	-	-	20.0/23.0	17.0/21.0	19.5/23.5	14.5/16.5	20.0/22.5
Ti	-	.35/.85	.40 Max	.65/1.15	.60/1.2	-	-
Cb+Ta	-	-	3.15/4.15	4.75/5.50	-	-	-
Al	-	2.3/3.15	.40 Max	.20/.80	0.2	-	-
Fe	2.5 Max	2.00 Max	5.0 Max	Balance	22.0 Min	4.0/7.0	2.0/6.0
Mo	-	-	8.0/10.0	2.8/3.30	2.5/3.5	15.0/17.0	12.5/14.5
Cu	28.0/34.0	Balance	-	.30 Max	1.5/3.0	-	-
Other	-	-	P: .015 Max	-	-	Co: 2.5 Max P: .04 Max V: .35 Max W: 3.0/4.5	Co: 2.5 Max P: .025 Max V: .35 Max W: 2.5/3.5

MECHANICAL PROPERTIES OF SEAMLESS TUBING

Mechanical Properties- Stainless Steel* (Normal Diameter and Wall)

Alloy	Temper	Tensile Strength (ksi)	Yield Strength (ksi)	Min. Elong. in 2 inches	Rockwell Hardness
304	1	100 Max	30	35	B90 Max
	1/8 Hard	105-140	75-110	20	-
	2	125-150	85-125	15	C30 Max
	3	150 Min.	115-160	7	C40 Max
304L	1	100 Max	25	35	B90 Max
	1/8 Hard	105-140	75-110	20	-
	2	110-140	75-110	15	C25 Max
	3	140 Min.	110-150	7	C38 Max
310	1	100 Max	35	35	B95 Max
	2	115-135	70-115	15	C26 Max
	3	145 Min.	110-160	5	C38 Max
316	1	100 Max	30	35	B95 Max
	2	115-135	70-110	15	C26 Max
	3	145 Min.	105-150	6	C38 Max
316L	1	100 Max	25	35	B95 Max
	2	115-135	70-110	15	C26 Max
	3	145 Min.	105-150	6	C38 Max
321	1	105 Max	30	35	B92 Max
	2	110-135	80-115	15	C26 Max
	3	140 Min.	125-160	6	C38 Max
347	1	105 Max	30	35	B92 Max
	2	110-135	80-115	12	C26 Max
	3	140 Min.	125-160	6	C38 Max

Mechanical Properties- Nickel & Nickel Base Alloys** (Normal Diameter and Wall)

Alloy	Temper	Tensile Strength (ksi)	Yield Strength (ksi)	Min. Elong. in 2 inches	Rockwell Hardness
Alloy 400	1	85 Max	28	32	B80 Max
	2	90-105	55-80	12	B97 Max
	3	110 Min.	90-120	3	C27 Max
Alloy 500	1	110 Max	40	28	B95 Max
	2	110-130	65-95	10	C23 Max
	3	130 Min.	90-110	4	C26 Max
Alloy 625	1	85-115	35 Min	30	B90 Max
Alloy 825	1	120 Max	60 Max	30	-
Alloy C22	1	100 Min	41 Min	40	-
Alloy C276	1	100 Min	45 Min	45	-

Note:

Temper - #1 Annealed; #2 Half Hard; #3 Full Hard

*Properties shown above are for sizes larger than .125" and heavier than .015" wall.

**Properties shown are for larger than .188" O.D. heavier than .020" wall.

In cases of dispute, tensile strength will be considered referee.

Parker Safety Guide

Parker Safety Guide for Selecting and Using Hose, Tubing, Fittings, Connectors, Conductors, Valves and Related Accessories



Parker Safety Guide for Selecting and Using Hose, Tubing, Fittings and Related Accessories

Publication No. 4400-B.1

Revised: October 2015, Rev A

WARNING: Failure or improper selection or improper use of hose, tubing, fittings, assemblies, valves, connectors, conductors or related accessories ("Products") can cause death, personal injury and property damage. Possible consequences of failure or improper selection or improper use of these Products include but are not limited to:

- Fittings thrown off at high speed.
- High velocity fluid discharge.
- Explosion or burning of the conveyed fluid.
- Electrocution from high voltage electric powerlines.
- Contact with suddenly moving or falling objects that are controlled by the conveyed fluid.
- Injections by high-pressure fluid discharge.

- Dangerously whipping Hose.
- Tube or pipe burst.
- Weld joint fracture.
- Contact with conveyed fluids that may be hot, cold, toxic or otherwise injurious.
- Sparking or explosion caused by static electricity buildup or other sources of electricity.
- Sparking or explosion while spraying paint or flammable liquids.
- Injuries resulting from inhalation, ingestion or exposure to fluids.

Before selecting or using any of these Products, it is important that you read and follow the instructions below. No product from any division in Parker Fluid Connectors Group is approved for in-flight aerospace applications. For hoses and fittings used in in-flight aerospace applications, please contact Parker Aerospace Group.

1.0 GENERAL INSTRUCTIONS

1.1 Scope: This safety guide provides instructions for selecting and using (including assembling, installing, and maintaining) these Products. For convenience, all rubber and/or thermoplastic products commonly called "hose" or "tubing" are called "Hose" in this safety guide. Metallic tube or pipe are called "tube". All assemblies made with Hose are called "Hose Assemblies". All assemblies made with Tube are called "Tube Assemblies".

All products commonly called "fittings", "couplings" or "adapters" are called "Fittings". Valves are fluid system components that control the passage of fluid. Related accessories are ancillary devices that enhance or monitor performance including crimping, flaring, flanging, presetting, bending, cutting, deburring, swaging machines, sensors, tags, lockout handles, spring guards and associated tooling. This safety guide is a supplement to and is to be used with the specific Parker publications for the specific Hose, Fittings and Related Accessories that are being considered for use. Parker publications are available at www.parker.com. SAE J1273 (www.sae.org) and ISO 17165-2 (www.ansi.org) also provide recommended practices for hydraulic Hose Assemblies, and should be followed.

1.2 Fail-Safe: Hose, Hose Assemblies, Tube, Tube Assemblies and Fittings can and do fail without warning for many reasons. Design all systems and equipment in a fail-safe mode, so that failure of the Hose, Hose Assembly, Tube, Tube Assembly or Fitting will not endanger persons or property.

1.3 Distribution: Provide a copy of this safety guide to each person responsible for selecting or using Hose, Tube and Fitting products. Do not select or use Parker Hose, Tube or Fittings without thoroughly reading and understanding this safety guide as well as the specific Parker publications for the Products.

1.4 User Responsibility: Due to the wide variety of operating conditions and applications for Hose, Tube and Fittings. Parker does not represent or warrant that any particular Hose, Tube or Fitting is suitable for any specific end use system. This safety guide does not analyze all technical parameters that must be considered in selecting a product. The user, through its own analysis and testing, is solely responsible for:

- Making the final selection of the Products.
- Assuring that the user's requirements are met and that the application presents no health or safety hazards.
- Following the safety guide for Related Accessories and being trained to operate Related Accessories.
- Providing all appropriate health and safety warnings on the equipment on which the Products are used.
- Assuring compliance with all applicable government and industry standards.

1.5 Additional Questions: Call the appropriate Parker technical service department if you have any questions or require any additional information. See the Parker publication for the Products being considered or used, or call 1-800-CPARKER, or go to www.parker.com, for telephone numbers of the appropriate technical service department.

2.0 HOSE, TUBE & FITTINGS SELECTION INSTRUCTIONS

2.1 Electrical Conductivity: Certain applications require that the Hose be nonconductive to prevent electrical current flow. Other applications require the Hose and the Fittings and the Hose/Fitting interface to be sufficiently conductive to drain off static electricity. Extreme care must be exercised when selecting Hose, Tube and Fittings for these or any other applications in which electrical conductivity or nonconductivity is a factor.

The electrical conductivity or nonconductivity of Hose, Tube and Fittings is dependent upon many factors and may be susceptible to change. These factors include but are not limited to the various materials used to make the Hose and the Fittings, Fitting finish (some Fitting finishes are electrically conductive while others are nonconductive), manufacturing methods (including moisture control), how the Fittings contact the Hose, age and amount of deterioration or damage or other changes, moisture content of the Hose at any particular time, and other factors.

The following are considerations for electrically nonconductive and conductive Hose. For other applications consult the individual catalog pages and the appropriate industry or regulatory standards for proper selection.

2.1.1 Electrically Nonconductive Hose: Certain applications require that the Hose be nonconductive to prevent electrical current flow or to maintain electrical isolation. For applications that require Hose to be electrically nonconductive, including but not limited to applications near high voltage electric lines, only special nonconductive Hose can be used. The manufacturer of the equipment in which the nonconductive Hose is to be used must be consulted to be certain that the Hose, Tube and Fittings that are selected are proper for the application. Do not use any Parker Hose or Fittings for any such application requiring nonconductive Hose, including but not limited to applications near high voltage electric lines or dense magnetic fields, unless (i) the application is expressly approved in the Parker technical publication for the product, (ii) the Hose is marked "nonconductive", and (iii) the manufacturer of the equipment on which the Hose is to be used specifically approves the particular Parker Hose, Tube and Fittings for such use.

2.1.2 Electrically Conductive Hose: Parker manufactures special Hose for certain applications that require electrically conductive Hose. Parker manufactures special Hose for conveying paint in airless paint spraying applications. This Hose is labeled "Electrically Conductive Airless Paint Spray Hose" on its layline and packaging. This Hose must be properly connected to the appropriate Parker Fittings and properly grounded in order to dissipate dangerous static charge buildup, which occurs in all airless paint spraying applications. Do not use any other Hose or failure to properly connect the Hose can cause a fire or an explosion resulting in death, personal injury, and property damage. All hoses that convey fuels must be grounded.

Parker manufactures a special Hose for certain compressed natural gas ("CNG") applications where static electricity buildup may occur. Parker CNG Hose assemblies comply with the requirements of ANSI/IAS NGV 4.2; CSA 12.52, "Hoses for Natural Gas Vehicles and Dispensing Systems" (www.ansi.org). This Hose is labeled "Electrically Conductive for CNG Use" on its layline and packaging. This Hose must be properly connected to

the appropriate Parker Fittings and properly grounded in order to dissipate dangerous static charge buildup, which occurs in, for example, high velocity CNG dispensing or transfer. Do not use any other Hose for CNG applications where static charge buildup may occur, even if electrically conductive. Use of other Hoses in CNG applications or failure to properly connect or ground this Hose can cause a fire or an explosion resulting in death, personal injury, and property damage. Care must also be taken to protect against CNG permeation through the Hose wall. See section 2.6, Permeation, for more information. Parker CNG Hose is intended for dispenser and vehicle use within the specified temperature range. Parker CNG Hose should not be used in confined spaces or unventilated areas or areas exceeding the specified temperature range. Final assemblies must be tested for leaks. CNG Hose Assemblies should be tested on a monthly basis for conductivity per ANSI/IAS NGV 4.2; CSA 12.52.

Parker manufactures special Hose for aerospace in-flight applications. Aerospace in-flight applications employing Hose to transmit fuel, lubricating fluids and hydraulic fluids require a special Hose with a conductive inner tube. This Hose for in-flight applications is available only from Parker's Stratoflex Products Division. Do not use any other Parker Hose for in-flight applications, even if electrically conductive. Use of other Hoses for in-flight applications or failure to properly connect or ground this Hose can cause a fire or an explosion resulting in death, personal injury and property damage. These Hose assemblies for in-flight applications must meet all applicable aerospace industry, aircraft engine and aircraft requirements.

2.2 Pressure: Hose, Tube and Fitting selection must be made so that the published maximum working pressure of the Hose, Tube and Fittings are equal to or greater than the maximum system pressure. The maximum working pressure of a Hose, or Tube Assembly is the lower of the respective published maximum working pressures of the Hose, Tube and the Fittings used. Surge pressures or peak transient pressures in the system must be below the published maximum working pressure for the Hose, Tube and Fitting. Surge pressures and peak pressures can usually only be determined by sensitive electrical instrumentation that measures and indicates pressures at millisecond intervals. Mechanical pressure gauges indicate only average pressures and cannot be used to determine surge pressures or peak transient pressures. Published burst pressure ratings for Hose is for manufacturing test purposes only and is no indication that the Product can be used in applications at the burst pressure or otherwise above the published maximum recommended working pressure.

2.3 Suction: Hoses used for suction applications must be selected to insure that the Hose will withstand the vacuum and pressure of the system. Improperly selected Hose may collapse in suction application.

2.4 Temperature: Be certain that fluid and ambient temperatures, both steady and transient, do not exceed the limitations of the Hose, Tube, Fitting and Seals. Temperatures below and above the recommended limit can degrade Hose, Tube, Fittings and Seals to a point where a failure may occur and release fluid. Tube and Fittings performances are normally degraded at elevated temperature. Material compatibility can also change at temperatures outside of the rated range. Properly insulate and protect the Hose Assembly when routing near hot objects (e.g. manifolds). Do not use any Hose in any application where failure of the Hose could result in the conveyed fluids (or vapors or mist from the conveyed fluids) contacting any open flame, molten metal, or other potential fire ignition source that could cause burning or explosion of the conveyed fluids or vapors.

2.5 Fluid Compatibility: Hose, and Tube Assembly selection must assure compatibility of the Hose tube, cover, reinforcement, Tube, Plating and Seals with the fluid media used. See the fluid compatibility chart in the Parker publication for the product being considered or used. This information is offered only as a guide. Actual service life can only be determined by the end user by testing under all extreme conditions and other analysis.

Hose, and Tube that is chemically compatible with a particular fluid must be assembled using Fittings and adapters containing likewise compatible seals. Flange or flare processes can change Tube material properties that may not be compatible with certain requirements such as NACE

2.6 Permeation: Permeation (that is, seepage through the Hose or Seal) will occur from inside the Hose or Fitting to outside when Hose or Fitting is used with gases, liquid and gas fuels, and refrigerants (including but not limited to such materials as helium, diesel fuel, gasoline, natural gas, or LPG). This permeation may result in high concentrations of vapors which are potentially flammable, explosive, or toxic, and in loss of fluid. Dangerous explosions, fires, and other hazards can result when using the wrong Hose for such applications. The system designer must take into account the fact that this permeation will take place and must not use Hose or Fitting if this permeation could be hazardous. The

system designer must take into account all legal, government, insurance, or any other special regulations which govern the use of fuels and refrigerants. Never use a Hose or Fitting even though the fluid compatibility is acceptable without considering the potential hazardous effects that can result from permeation through the Hose or Tube Assembly. Permeation of moisture from outside the Hose or Fitting to inside the Hose or Fitting will also occur in Hose or Tube assemblies, regardless of internal pressure. If this moisture permeation would have detrimental effects (particularly, but not limited to refrigeration and air conditioning systems), incorporation of sufficient drying capacity in the system or other appropriate system safeguards should be selected and used. The sudden pressure release of highly pressurized gas could also result in Explosive Decompression failure of permeated Seals and Hoses.

2.7 Size: Transmission of power by means of pressurized fluid varies with pressure and rate of flow. The size of the components must be adequate to keep pressure losses to a minimum and avoid damage due to heat generation or excessive fluid velocity.

2.8 Routing: Attention must be given to optimum routing to minimize inherent problems (kinking or flow restriction due to Hose collapse, twisting of the Hose, proximity to hot objects or heat sources). For additional routing recommendations see SAE J1273 and ISO 17165-2. Hose Assemblies have a finite life and should be installed in a manner that allows for ease of inspection and future replacement. Hose because of its relative short life, should not be used in residential and commercial buildings inside of inaccessible walls or floors, unless specifically allowed in the product literature. Always review all product literature for proper installation and routing instructions.

2.9 Environment: Care must be taken to insure that the Hose, Tube and Fittings are either compatible with or protected from the environment (that is, surrounding conditions) to which they are exposed. Environmental conditions including but not limited to ultraviolet radiation, sunlight, heat, ozone, moisture, water, salt water, chemicals and air pollutants can cause degradation and premature failure.

2.10 Mechanical Loads: External forces can significantly reduce Hose, Tube and Fitting life or cause failure. Mechanical loads which must be considered include excessive flexing, twist, kinking, tensile or side loads, bend radius, and vibration. Use of swivel type Fittings or adapters may be required to insure no twist is put into the Hose. Use of proper Hose or Tube clamps may also be required to reduce external mechanical loads. Unusual applications may require special testing prior to Hose selection.

2.11 Physical Damage: Care must be taken to protect Hose from wear, snagging, kinking, bending smaller than minimum bend radius and cutting, any of which can cause premature Hose failure. Any Hose that has been kinked or bent to a radius smaller than the minimum bend radius, and any Hose that has been cut or is cracked or is otherwise damaged should be removed and discarded. Fittings with damages such as scratches on sealing surfaces and deformation should be replaced.

2.12 Proper End Fitting: See instructions 3.2 through 3.5. These recommendations may be substantiated by testing to industry standards such as SAE J517 for hydraulic applications, or MIL-A-5070, AS1339, or AS3517 for Hoses from Parker's Stratoflex Products Division for aerospace applications.

2.13 Length: When determining the proper Hose or Tube length of an assembly, be aware of Hose length change due to pressure, Tube length change due to thermal expansion or contraction, and Hose or Tube and machine tolerances and movement must be considered. When routing short hose assemblies, it is recommended that the minimum free hose length is always used. Consult the hose manufacturer for their minimum free hose length recommendations. Hose assemblies should be installed in such a way that any motion or flexing occurs within the same plane.

2.14 Specifications and Standards: When selecting Hose, Tube and Fittings, government, industry, and Parker specifications and recommendations must be reviewed and followed as applicable.

2.15 Hose Cleanliness: Hose and Tube components may vary in cleanliness levels. Care must be taken to insure that the Hose and Tube Assembly selected has an adequate level of cleanliness for the application.

2.16 Fire Resistant Fluids: Some fire resistant fluids that are to be conveyed by Hose or Tube require use of the same type of Hose or Tube as used with petroleum base fluids. Some such fluids require a special Hose, Tube, Fitting and Seal, while a few fluids will not work with any Hose at all. See instructions 2.5 and 1.5. The wrong Hose, Tube, Fitting or Seal may fail after a very short service. In addition, all liquids but pure water may burn fiercely under certain conditions, and even pure water leakage may be hazardous.

2.17 Radiant Heat: Hose and Seals can be heated to destruction without contact by such nearby items as hot manifolds or molten metal. The same heat source may then initiate a fire. This can occur despite the presence of cool air around the Hose or Seal. Performance of Tube and Fitting subjected to the heat could be degraded.

2.18 Welding or Brazing: When using a torch or arc welder in close proximity to hydraulic lines, the hydraulic lines should be removed or shielded with appropriate fire resistant materials. Flame or weld spatter could burn through the Hose or Seal and possibly ignite escaping fluid resulting in a catastrophic failure. Heating of plated parts, including Hose Fittings and adapters, above 450°F (232°C) such as during welding, brazing or soldering may emit deadly gases. Any elastomer seal on fittings shall be removed prior to welding or brazing, any metallic surfaces shall be protected after brazing or welding when necessary. Welding and brazing filler material shall be compatible with the Tube and Fitting that are joined.

2.19 Atomic Radiation: Atomic radiation affects all materials used in Hose and Tube assemblies. Since the long-term effects may be unknown, do not expose Hose or Tube assemblies to atomic radiation. Nuclear applications may require special Tube and Fittings.

2.20 Aerospace Applications: The only Hose, Tube and Fittings that may be used for in-flight aerospace applications are those available from Parker's Stratoflex Products Division. Do not use any other Hose or Fittings for in-flight applications. Do not use any Hose or Fittings from Parker's Stratoflex Products Division with any other Hose or Fittings, unless expressly approved in writing by the engineering manager or chief engineer of Stratoflex Products Division and verified by the user's own testing and inspection to aerospace industry standards.

2.21 Unlocking Couplings: Ball locking couplings or other Fittings with quick disconnect ability can unintentionally disconnect if they are dragged over obstructions, or if the sleeve or other disconnect member, is bumped or moved enough to cause disconnect. Threaded Fittings should be considered where there is a potential for accidental uncoupling.

3.0 HOSE AND FITTINGS ASSEMBLY AND INSTALLATION INSTRUCTIONS

3.1 Component Inspection: Prior to assembly, a careful examination of the Hose and Fittings must be performed. All components must be checked for correct style, size, catalog number, and length. The Hose must be examined for cleanliness, obstructions, blisters, cover looseness, kinks, cracks, cuts or any other visible defects. Inspect the Fitting and sealing surfaces for burrs, nicks, corrosion or other imperfections. Do NOT use any component that displays any signs of nonconformance.

3.2 Hose and Fitting Assembly: Do not assemble a Parker Fitting on a Parker Hose that is not specifically listed by Parker for that Fitting, unless authorized in writing by the engineering manager or chief engineer of the appropriate Parker division. Do not assemble a Parker Fitting on another manufacturer's Hose or a Parker Hose on another manufacturer's Fitting unless (i) the engineering manager or chief engineer of the appropriate Parker division approves the Assembly in writing or that combination is expressly approved in the appropriate Parker literature for the specific Parker product, and (ii) the user verifies the Assembly and the application through analysis and testing. For Parker Hose that does not specify a Parker Fitting, the user is solely responsible for the selection of the proper Fitting and Hose Assembly procedures. See instruction 1.4.

To prevent the possibility of problems such as leakage at the Fitting or system contamination, it is important to completely remove all debris from the cutting operation before installation of the Fittings. The Parker published instructions must be followed for assembling the Fittings on the Hose. These instructions are provided in the Parker Fitting catalog for the specific Parker Fitting being used, or by calling 1-800-CPARKER, or at www.parker.com.

3.3 Related Accessories: Do not crimp or swage any Parker Hose or Fitting with anything but the listed swage or crimp machine and dies in accordance with Parker published instructions. Do not crimp or swage another manufacturer's Fitting with a Parker crimp or swage die unless authorized in writing by the engineering manager or chief engineer of the appropriate Parker division.

3.4 Parts: Do not use any Parker Fitting part (including but not limited to socket, shell, nipple, or insert) except with the correct Parker mating parts, in accordance with Parker published instructions, unless authorized in writing by the engineering manager or chief engineer of the appropriate Parker division.

3.5 Field Attachable/Permanent: Do not reuse any field attachable Hose Fitting that has blown or pulled off a Hose. Do not reuse a Parker permanent Hose Fitting (crimped or swaged) or any part thereof. Complete

Hose Assemblies may only be reused after proper inspection under section 4.0. Do not assemble Fittings to any previously used hydraulic Hose that was in service, for use in a fluid power application.

3.6 Pre-Installation Inspection: Prior to installation, a careful examination of the Hose Assembly must be performed. Inspect the Hose Assembly for any damage or defects. DO NOT use any Hose Assembly that displays any signs of nonconformance.

3.7 Minimum Bend Radius: Installation of a Hose at less than the minimum listed bend radius may significantly reduce the Hose life. Particular attention must be given to preclude sharp bending at the Hose to Fitting juncture. Any bending during installation at less than the minimum bend radius must be avoided. If any Hose is kinked during installation, the Hose must be discarded.

3.8 Twist Angle and Orientation: Hose Assembly installation must be such that relative motion of machine components does not produce twisting.

3.9 Securement: In many applications, it may be necessary to restrain, protect, or guide the Hose to protect it from damage by unnecessary flexing, pressure surges, and contact with other mechanical components. Care must be taken to insure such restraints do not introduce additional stress or wear points.

3.10 Proper Connection of Ports: Proper physical installation of the Hose Assembly requires a correctly installed port connection insuring that no twist or torque is transferred to the Hose when the Fittings are being tightened or otherwise during use.

3.11 External Damage: Proper installation is not complete without insuring that tensile loads, side loads, kinking, flattening, potential abrasion, thread damage or damage to sealing surfaces are corrected or eliminated. See instruction 2.10.

3.12 System Checkout: All air entrapment must be eliminated and the system pressurized to the maximum system pressure (at or below the Hose maximum working pressure) and checked for proper function and freedom from leaks. Personnel must stay out of potential hazardous areas while testing and using.

3.13 Routing: The Hose Assembly should be routed in such a manner so if a failure does occur, the escaping media will not cause personal injury or property damage. In addition, if fluid media comes in contact with hot surfaces, open flame or sparks, a fire or explosion may occur. See section 2.4.

3.14 Ground Fault Equipment Protection Devices (GFEPDs): WARNING! Fire and Shock Hazard. To minimize the danger of fire if the heating cable of a Multitube bundle is damaged or improperly installed, use a Ground Fault Equipment Protection Device. Electrical fault currents may be insufficient to trip a conventional circuit breaker.

For ground fault protection, the IEEE 515: (www.ansi.org) standard for heating cables recommends the use of GFEPDs with a nominal 30 milliampere trip level for "piping systems in classified areas, those areas requiring a high degree of maintenance, or which may be exposed to physical abuse or corrosive atmospheres".

4.0 TUBE AND FITTINGS ASSEMBLY AND INSTALLATION INSTRUCTIONS

4.1 Component Inspection: Prior to assembly, a careful examination of the Tube and Fittings must be performed. All components must be checked for correct style, size, material, seal, and length. Inspect the Fitting and sealing surfaces for burrs, nicks, corrosion, missing seal or other imperfections. Do NOT use any component that displays any signs of nonconformance.

4.2 Tube and Fitting Assembly: Do not assemble a Parker Fitting with a Tube that is not specifically listed by Parker for that Fitting, unless authorized in writing by the engineering manager or chief engineer of the appropriate Parker division. The Tube must meet the requirements specified to the Fitting. The Parker published instructions must be followed for assembling the Fittings to a Tube. These instructions are provided in the Parker Fitting catalog for the specific Parker Fitting being used, or by calling 1-800-CPARKER, or at www.parker.com.

4.3 Related Accessories: Do not preset or flange Parker Fitting components using another manufacturer's equipment or procedures unless authorized in writing by the engineering manager or chief engineer of the appropriate Parker division. Tube, Fitting component and tooling must be checked for correct style, size and material. Operation and maintenance of Related Accessories must be in accordance with the operation manual for the designated Accessory.

4.4 Securement: In many applications, it may be necessary to restrain, protect, or guide the Tube to protect it from damage by unnecessary flexing, pressure surges, vibration, and contact with other mechanical components. Care must be taken to insure such restraints do not introduce additional stress or wear points.

4.5 Proper Connection of Ports: Proper physical installation of the Tube Assembly requires a correctly installed port connection insuring that no torque is transferred to the Tube when the Fittings are being tightened or otherwise during use.

4.6 External Damage: Proper installation is not complete without insuring that tensile loads, side loads, flattening, potential abrasion, thread damage or damage to sealing surfaces are corrected or eliminated. See instruction 2.10.

4.7 System Checkout: All air entrapment must be eliminated and the system pressurized to the maximum system pressure (at or below the Tube Assembly maximum working pressure) and checked for proper function and freedom from leaks. Personnel must stay out of potential hazardous areas while testing and using.

4.8 Routing: The Tube Assembly should be routed in such a manner so if a failure does occur, the escaping media will not cause personal injury or property damage. In addition, if fluid media comes in contact with hot surfaces, open flame or sparks, a fire or explosion may occur. See section 2.4.

5.0 HOSE AND FITTING MAINTENANCE AND REPLACEMENT INSTRUCTIONS

5.1 Even with proper selection and installation, Hose life may be significantly reduced without a continuing maintenance program. The severity of the application, risk potential from a possible Hose failure, and experience with any Hose failures in the application or in similar applications should determine the frequency of the inspection and the replacement for the Products so that Products are replaced before any failure occurs. Certain products require maintenance and inspection per industry requirements. Failure to adhere to these requirements may lead to premature failure. A maintenance program must be established and followed by the user and, at minimum, must include instructions 5.2 through 5.7

5.2 Visual Inspection Hose/Fitting: Any of the following conditions require immediate shut down and replacement of the Hose Assembly:

- Fitting slippage on Hose;
- Damaged, cracked, cut or abraded cover (any reinforcement exposed);
- Hard, stiff, heat cracked, or charred Hose;
- Cracked, damaged, or badly corroded Fittings;
- Leaks at Fitting or in Hose;
- Kinked, crushed, flattened or twisted Hose; and
- Blistered, soft, degraded, or loose cover.

5.3 Visual Inspection All Other: The following items must be tightened, repaired, corrected or replaced as required:

- Leaking port conditions;
- Excess dirt buildup;/
- Worn clamps, guards or shields; and
- System fluid level, fluid type, and any air entrapment.

5.4 Functional Test: Operate the system at maximum operating pressure and check for possible malfunctions and leaks. Personnel must avoid potential hazardous areas while testing and using the system. See section 2.2.

5.5 Replacement Intervals: Hose assemblies and elastomeric seals used on Hose Fittings and adapters will eventually age, harden, wear and deteriorate under thermal cycling and compression set. Hose Assemblies and elastomeric seals should be inspected and replaced at specific replacement intervals, based on previous service life, government or industry recommendations, or when failures could result in unacceptable downtime, damage, or injury risk. See section 1.2. Hose and Fittings may be subjected to internal mechanical and/or chemical wear from the conveying fluid and may fail without warning. The user must determine the product life under such circumstances by testing. Also see section 2.5.

5.6 Hose Inspection and Failure: Hydraulic power is accomplished by utilizing high pressure fluids to transfer energy and do work. Hoses, Fittings and Hose Assemblies all contribute to this by transmitting fluids at high pressures. Fluids under pressure can be dangerous and potentially lethal and, therefore, extreme caution must be exercised when working with fluids under pressure and handling the Hoses transporting the fluids. From time to time, Hose Assemblies will fail if they are not replaced at proper time intervals. Usually these failures are the result of some form of misapplication, abuse, wear or failure to perform proper maintenance. When Hoses fail, generally the high pressure fluids inside escape in a stream which may or may not be visible to the user. Under no circumstances should the user attempt to locate the leak by "feeling" with their hands or any other part of their body. High pressure fluids can and will penetrate the skin and cause severe tissue damage and

possibly loss of limb. Even seemingly minor hydraulic fluid injection injuries must be treated immediately by a physician with knowledge of the tissue damaging properties of hydraulic fluid.

If a Hose failure occurs, immediately shut down the equipment and leave the area until pressure has been completely released from the Hose Assembly. Simply shutting down the hydraulic pump may or may not eliminate the pressure in the Hose Assembly. Many times check valves, etc., are employed in a system and can cause pressure to remain in a Hose Assembly even when pumps or equipment are not operating. Tiny holes in the Hose, commonly known as pinholes, can eject small, dangerously powerful but hard to see streams of hydraulic fluid. It may take several minutes or even hours for the pressure to be relieved so that the Hose Assembly may be examined safely.

Once the pressure has been reduced to zero, the Hose Assembly may be taken off the equipment and examined. It must always be replaced if a failure has occurred. Never attempt to patch or repair a Hose Assembly that has failed. Consult the nearest Parker distributor or the appropriate Parker division for Hose Assembly replacement information. .

Never touch or examine a failed Hose Assembly unless it is obvious that the Hose no longer contains fluid under pressure. The high pressure fluid is extremely dangerous and can cause serious and potentially fatal injury.

5.7 Elastomeric seals: Elastomeric seals will eventually age, harden, wear and deteriorate under thermal cycling and compression set. Elastomeric seals should be inspected and replaced.

5.8 Refrigerant gases: Special care should be taken when working with refrigeration systems. Sudden escape of refrigerant gases can cause blindness if the escaping gases contact the eye and can cause freezing or other severe injuries if it contacts any other portion of the body.

5.9 Compressed natural gas (CNG): Parker CNG Hose Assemblies should be tested after installation and before use, and at least on a monthly basis per instructions provided on the Hose Assembly tag. The recommended procedure is to pressurize the Hose and check for leaks and to visually inspect the Hose for damage and to perform an electrical resistance test.

Caution: Matches, candles, open flame or other sources of ignition shall not be used for Hose inspection. Leak check solutions should be rinsed off after use.

6.0 HOSE STORAGE

6.1 Age Control: Hose and Hose Assemblies must be stored in a manner that facilitates age control and first-in and first-out usage based on manufacturing date of the Hose and Hose Assemblies. Unless otherwise specified by the manufacturer or defined by local laws and regulations:

6.1.1 The shelf life of rubber hose in bulk form or hose made from two or more materials is 28 quarters (7 years) from the date of manufacture, with an extension of 12 quarters (3 years), if stored in accordance with ISO 2230;

6.1.2 The shelf life of thermoplastic and polytetrafluoroethylene hose is considered to be unlimited;

6.1.3 Hose assemblies that pass visual inspection and proof test shall not be stored for longer than 2 years.

6.1.4 Storage: Stored Hose and Hose Assemblies must not be subjected to damage that could reduce their expected service life and must be placed in a cool, dark and dry area with the ends capped. Stored Hose and Hose Assemblies must not be exposed to temperature extremes, ozone, oils, corrosive liquids or fumes, solvents, high humidity, rodents, insects, ultraviolet light, electromagnetic fields or radioactive materials.

ENERPAC Warranty Policy

For those ENERPAC items sold as part of the Parker Parflex Division product offering, the following warranty applies.

ENERPAC products are warranted to be free of defects in materials and workmanship under normal use for as long as they are owned by the original purchaser, subject to the exclusions and limitations described below. This warranty does not cover ordinary wear and tear, overloading, alterations, (including repairs or attempted repairs by parties other than ENERPAC or its authorized service representatives), improper fluid, use in a manner for which they are not intended or use which is contrary to instructions for the products.

THIS WARRANTY IS LIMITED TO NEW PRODUCTS SOLD THROUGH ENERPAC AUTHORIZED DISTRIBUTORS, ORIGINAL EQUIPMENT MANUFACTURERS OR OTHER DESIGNATED CHANNELS OF DISTRIBUTION. NO AGENT, EMPLOYEE, OR OTHER REPRESENTATIVE OF ENERPAC HAS THE AUTHORITY TO IN ANY WAY CHANGE OR AMEND THIS WARRANTY.

Electronic products and components are warranted against defects in material and workmanship for a period of two years from the date of purchase.

The following items supplied with ENERPAC products are excluded from this warranty:

Components not manufactured by ENERPAC, including air motors, electric motors, gasoline engines, and diesel engines. Such items are warranted to the extent of the warranty provided by the manufacturers of such items.

If the customer believes a product is defective, the product must be delivered, or shipped freight prepaid, to the nearest ENERPAC Authorized Service Center. The customer should contact ENERPAC to locate and Authorized Service Center in the customer's area.

Products that do not conform to this warranty will be returned by ground transportation, freight prepaid.

THE FOREGOING WARRANT IS EXCLUSIVE AND IS IN LIEU OF ALL OTHER EXPRESS AND IMPLIED WARRANTIES, INCLUDING BUT NOT LIMITED TO THE IMPLIED WARRANTIES OF MERCHANTABILITY AND FITNESS FOR A PARTICULAR PURPOSE.

The remedy of repair, replacement or refund is customer's exclusive remedy in the event of breach of this warranty.

SELLER SHALL NOT BE SUBJECT TO AND DISCLAIMS:

- (a) ANY OTHER OBLIGATIONS OR LIABILITIES ARISING OUT OF BREACH OF CONTRACT OR OF WARRANTY,
- (b) ANY OBLIGATIONS WHATSOEVER ARISING FROM TORT CLAIMS (INCLUDING NEGLIGENCE AND STRICT LIABILITY) OR ARISING UNDER THEORIES OR LAW WITH RESPECT TO PRODUCTS SOLD OR SERVICES RENDERED BY SELLER OR ANY UNDERTAKINGS, ACTS OR OMISSIONS RELATING THERETO, AND
- (c) ALL CONSEQUENTIAL, INCIDENTAL AND CONTINGENT DAMAGES WHATSOEVER.

ENERPAC's liability in all cases is limited to, and shall not exceed, the purchase price paid.

For the nearest authorized ENERPAC SERVICE CENTER, please call ENERPAC at 1-800-558-0530 or visit the ENERPAC web site at www.Enerpac.com.

Offer of Sale

PARKER-HANNIFIN CORPORATION OFFER OF SALE

1. **Definitions.** As used herein, the following terms have the meanings indicated.

Buyer:	means any customer receiving a Quote for Products from Seller.
Goods:	means any tangible part, system or component to be supplied by the Seller.
Products:	means the Goods, Services and/or Software as described in a Quote provided by the Seller.
Quote:	means the offer or proposal made by Seller to Buyer for the supply of Products.
Seller:	means Parker-Hannifin Corporation, including all divisions and businesses thereof.
Services:	means any services to be supplied by the Seller.
Software:	means any software related to the Products, whether embedded or separately downloaded.
Terms:	means the terms and conditions of this Offer of Sale or any newer version of the same as published by Seller electronically at www.parker.com/saleterms .

2. **Terms.** All sales of Products by Seller are contingent upon, and will be governed by, these Terms and, these Terms are incorporated into any Quote provided by Seller to any Buyer. Buyer's order for any Products whether communicated to Seller verbally, in writing, by electronic data interface or other electronic commerce, shall constitute acceptance of these Terms. Seller objects to any contrary or additional terms or conditions of Buyer. Reference in Seller's order acknowledgement to Buyer's purchase order or purchase order number shall in no way constitute an acceptance of any of Buyer's terms of purchase. No modification to these Terms will be binding on Seller unless agreed to in writing and signed by an authorized representative of Seller.
3. **Price; Payment.** The Products set forth in Seller's Quote are offered for sale at the prices indicated in Seller's Quote. Unless otherwise specifically stated in Seller's Quote, prices are valid for thirty (30) days and do not include any sales, use, or other taxes or duties. Seller reserves the right to modify prices at any time to adjust for any raw material price fluctuations. Unless otherwise specified by Seller, all prices are F.C.A. Seller's facility (INCOTERMS 2010). All sales are contingent upon credit approval and payment for all purchases is due thirty (30) days from the date of invoice (or such date as may be specified in the Quote). Unpaid invoices beyond the specified payment date incur interest at the rate of 1.5% per month or the maximum allowable rate under applicable law.
4. **Shipment; Delivery; Title and Risk of Loss.** All delivery dates are approximate. Seller is not responsible for damages resulting from any delay. Regardless of the manner of shipment, delivery occurs and title and risk of loss or damage pass to Buyer, upon placement of the Products with the shipment carrier at Seller's facility. Unless otherwise agreed, Seller may exercise its judgment in choosing the carrier and means of delivery. No deferral of shipment at Buyers' request beyond the respective indicated shipping date will be made except on terms that will indemnify, defend and hold Seller harmless against all loss and additional expense. Buyer shall be responsible for any additional shipping charges incurred by Seller due to Buyer's acts or omissions.
5. **Warranty.** The warranty related to the Products is as follows: (i) Goods are warranted against defects in material or workmanship for a period of twelve (12) months from the date of delivery or 2,000 hours of use, whichever occurs first; (ii) Services shall be performed in accordance with generally accepted practices and using the degree of care and skill that is ordinarily exercised and customary in the field to which the Services pertain and are warranted for a period of six (6) months from the completion of the Services by Seller; and (iii) Software is only warranted to perform in accordance with applicable specifications provided by Seller to Buyer for ninety (90) days from the date of delivery or, when downloaded by a Buyer or end-user, from the date of the initial download. All prices are based upon the exclusive limited warranty stated above, and upon the following disclaimer:

DISCLAIMER OF WARRANTY: THIS WARRANTY IS THE SOLE AND ENTIRE WARRANTY PERTAINING TO PRODUCTS. SELLER DISCLAIMS ALL OTHER WARRANTIES, EXPRESS AND IMPLIED, INCLUDING DESIGN, NONINFRINGEMENT, MERCHANTABILITY, AND FITNESS FOR A PARTICULAR PURPOSE. SELLER DOES NOT WARRANT THAT THE SOFTWARE IS ERROR-FREE OR FAULT-TOLERANT, OR THAT

BUYER'S USE THEREOF WILL BE SECURE OR UNINTERRUPTED. BUYER AGREES AND ACKNOWLEDGES THAT UNLESS OTHERWISE AUTHORIZED IN WRITING BY SELLER THE SOFTWARE SHALL NOT BE USED IN CONNECTION WITH HAZARDOUS OR HIGH RISK ACTIVITIES OR ENVIRONMENTS. EXCEPT AS EXPRESSLY STATED HEREIN, ALL PRODUCTS ARE PROVIDED "AS IS".

6. **Claims; Commencement of Actions.** Buyer shall promptly inspect all Products upon receipt. No claims for shortages will be allowed unless reported to the Seller within ten (10) days of delivery. Buyer shall notify Seller of any alleged breach of warranty within thirty (30) days after the date the non-conformance is or should have been discovered by Buyer. Any claim or action against Seller based upon breach of contract or any other theory, including tort, negligence, or otherwise must be commenced within twelve (12) months from the date of the alleged breach or other alleged event, without regard to the date of discovery.
7. **LIMITATION OF LIABILITY.** IN THE EVENT OF A BREACH OF WARRANTY, SELLER WILL, AT ITS OPTION, REPAIR OR REPLACE THE NON-CONFORMING PRODUCT, RE-PERFORM THE SERVICES, OR REFUND THE PURCHASE PRICE PAID WITHIN A REASONABLE PERIOD OF TIME. **IN NO EVENT IS SELLER LIABLE FOR ANY SPECIAL, INDIRECT, INCIDENTAL OR CONSEQUENTIAL DAMAGES ARISING OUT OF, OR AS THE RESULT OF, THE SALE, DELIVERY, NON- DELIVERY, SERVICING, NON-COMPLETION OF SERVICES, USE, LOSS OF USE OF, OR INABILITY TO USE THE PRODUCTS OR ANY PART THEREOF, LOSS OF DATA, IDENTITY, PRIVACY, OR CONFIDENTIALITY, OR FOR ANY CHARGES OR EXPENSES OF ANY NATURE INCURRED WITHOUT SELLER'S WRITTEN CONSENT, WHETHER BASED IN CONTRACT, TORT OR OTHER LEGAL THEORY. IN NO EVENT SHALL SELLER'S LIABILITY UNDER ANY CLAIM MADE BY BUYER EXCEED THE PURCHASE PRICE PAID FOR THE PRODUCTS.**
8. **Loss to Buyer's Property.** Any designs, tools, patterns, materials, drawings, confidential information or equipment furnished by Buyer or any other items which are or become Buyer's property, will be considered obsolete and may be destroyed by Seller after two (2) consecutive years have elapsed without Buyer ordering the Products manufactured using such property. Seller shall not be responsible for any loss or damage to such property while it is in Seller's possession or control.
9. **Special Tooling.** Special Tooling includes but is not limited to tooling, jigs, fixtures and associated manufacturing equipment acquired or necessary to manufacture Products. A tooling charge may be imposed for any Special Tooling. Such Special Tooling shall be and remain Seller's property notwithstanding payment of any charges by Buyer. In no event will Buyer acquire any interest in Special Tooling belonging to Seller that is utilized in the manufacture of the Products, even if such Special Tooling has been specially converted or adapted for such manufacture and notwithstanding any charges paid by Buyer. Unless otherwise agreed, Seller has the right to alter, discard or otherwise dispose of any Special Tooling or other property in its sole discretion at any time.
10. **Security Interest.** To secure payment of all sums due, Seller retains a security interest in all Products delivered to Buyer and, Buyer's acceptance of these Terms is deemed to be a Security Agreement under the Uniform Commercial Code. Buyer authorizes Seller as its attorney to execute and file on Buyer's behalf all documents Seller deems necessary to perfect its security interest.
11. **User Responsibility.** The Buyer through its own analysis and testing, is solely responsible for making the final selection of the Products and assuring that all performance, endurance, maintenance, safety and warning requirements of the application of the Products are met. The Buyer must analyze all aspects of the application and follow applicable industry standards, specifications, and other technical information provided with the Product. If Seller provides Product options based upon data or specifications provided by the Buyer, the Buyer is responsible for determining that such data and specifications are suitable and sufficient for all applications and reasonably foreseeable uses of the Products. In the event the Buyer is not the end-user, Buyer will ensure such end-user complies with this paragraph.
12. **Use of Products, Indemnity by Buyer.** Buyer shall comply with all instructions, guides and specifications provided by Seller with the Products. Unauthorized Uses. If Buyer uses or resells the Products for any uses prohibited in Seller's instructions, guides or specifications, or Buyer otherwise fails to comply with Seller's instructions, guides and specifications, Buyer acknowledges that any such use, resale, or non-

Continued on next page

1. compliance is at Buyer's sole risk. Buyer shall indemnify, defend, and hold Seller harmless from any losses, claims, liabilities, damages, lawsuits, judgments and costs (including attorney fees and defense costs), whether for personal injury, property damage, intellectual property infringement or any other claim, brought by or incurred by Buyer, Buyer's employees, or any other person, arising out of: (a) improper selection, application, design, specification or other misuse of Products provided by Seller; (b) any act or omission, negligent or otherwise, of Buyer; (c) Seller's use of patterns, tooling, equipment, plans, drawings, designs or specifications or other information or things furnished by Buyer; (d) damage to the Products from an external cause, repair or attempted repair by anyone other than Seller, failure to follow instructions, guides and specifications provided by Seller, use with goods not provided by Seller, or opening, modifying, deconstructing or tampering with the Products for any reason; or (e) Buyer's failure to comply with these Terms. Seller shall not indemnify Buyer under any circumstance except as otherwise provided in these Terms.
2. **Cancellations and Changes.** Buyer may not cancel or modify any order for any reason, except with Seller's written consent and upon terms that will indemnify, defend and hold Seller harmless against all direct, incidental and consequential loss or damage. Seller, at any time, may change Product features, specifications, designs and availability.
3. **Limitation on Assignment.** Buyer may not assign its rights or obligations without the prior written consent of Seller.
4. **Force Majeure.** Seller does not assume the risk and is not liable for delay or failure to perform any of Seller's obligations by reason of events or circumstances beyond its reasonable control ("Events of Force Majeure"). Events of Force Majeure shall include without limitation: accidents, strikes or labor disputes, acts of any government or government agency, acts of nature, delays or failures in delivery from carriers or suppliers, shortages of materials, or any other cause beyond Seller's reasonable control.
5. **Waiver and Severability.** Failure to enforce any provision of these Terms will not invalidate that provision; nor will any such failure prejudice Seller's right to enforce that provision in the future. Invalidation of any provision of these Terms by legislation or other rule of law shall not invalidate any other provision herein and, the remaining provisions will remain in full force and effect.
6. **Termination.** Seller may terminate any agreement governed by or arising from these Terms for any reason and at any time by giving Buyer thirty (30) days prior written notice. Seller may immediately terminate, in writing, if Buyer: (a) breaches any provision of these Terms (b) appoints a trustee, receiver or custodian for all or any part of Buyer's property (c) files a petition for relief in bankruptcy on its own behalf, or one if filed by a third party (d) makes an assignment for the benefit of creditors; or (e) dissolves its business or liquidates all or a majority of its assets.
7. **Ownership of Software.** Seller retains ownership of all Software supplied to Buyer hereunder. In no event shall Buyer obtain any greater right in and to the Software than a right in the nature of a license limited to the use thereof and subject to compliance with any other terms provided with the Software.
8. **Indemnity for Infringement of Intellectual Property Rights.** Seller is not liable for infringement of any patents, trademarks, copyrights, trade dress, trade secrets or similar rights ("Intellectual Property Rights") except as provided in this Section. Seller will defend at its expense and will pay the cost of any settlement or damages awarded in an action brought against Buyer based on a third party claim that one or more of the Products sold hereunder infringes the Intellectual Property Rights of a third party in the country of delivery of the Products by the Seller to the Buyer. Seller's obligation to defend and indemnify Buyer is contingent on Buyer notifying Seller within ten (10) days after Buyer becomes aware of any such claim, and Seller having sole control over the defense of the claim including all negotiations for settlement or compromise. If one or more Products sold hereunder is subject to such a claim, Seller may, at its sole expense and option, procure for Buyer the right to continue using the Products, replace or modify the Products so as to render them non-infringing, or offer to accept return of the Products and refund the purchase price less a reasonable allowance for depreciation. Seller has no obligation or liability for any claim of infringement: (i) arising from information provided by Buyer; or (ii) directed to any Products provided hereunder for which the designs are specified in whole or part by Buyer; or (iii) resulting from the modification, combination or use in a system of any Products provided hereunder. The foregoing provisions of this Section constitute Seller's sole and exclusive liability and Buyer's sole and exclusive remedy for such claims of infringement of Intellectual Property Rights.
9. **Governing Law.** These Terms and the sale and delivery of all Products are deemed to have taken place in, and shall be governed and construed in accordance with, the laws of the State of Ohio, as applicable to contracts executed and wholly performed therein and without regard to conflicts of laws principles. Buyer irrevocably agrees and consents to the exclusive jurisdiction and venue of the courts of Cuyahoga County, Ohio with respect to any dispute, controversy or claim arising out of or relating to the sale and delivery of the Products.
10. **Entire Agreement.** These Terms, along with the terms set forth in the main body of any Quote, forms the entire agreement between the Buyer and Seller and constitutes the final, complete and exclusive expression of the terms of sale. In the event of a conflict between any term set forth in the main body of a Quote and these Terms, the terms set forth in the main body of the Quote shall prevail. All prior or contemporaneous written or oral agreements or negotiations with respect to the subject matter shall have no effect. These Terms may not be modified unless in writing and signed by an authorized representative of Seller.
11. **Compliance with Laws.** Buyer agrees to comply with all applicable laws, regulations, and industry and professional standards, including those of the United States of America, and the country or countries in which Buyer may operate, including without limitation the U.S. Foreign Corrupt Practices Act ("FCPA"), the U.S. Anti-Kickback Act ("Anti-Kickback Act"), U.S. and E.U. export control and sanctions laws ("Export Laws"), the U.S. Food Drug and Cosmetic Act ("FDCA"), and the rules and regulations promulgated by the U.S. Food and Drug Administration ("FDA"), each as currently amended. Buyer agrees to indemnify, defend, and hold harmless Seller from the consequences of any violation of such laws, regulations and standards by Buyer, its employees or agents. Buyer acknowledges that it is familiar with all applicable provisions of the FCPA, the Anti-Kickback Act, Export Laws, the FDCA and the FDA and certifies that Buyer will adhere to the requirements thereof and not take any action that would make Seller violate such requirements. Buyer represents and agrees that Buyer will not make any payment or give anything of value, directly or indirectly, to any governmental official, foreign political party or official thereof, candidate for foreign political office, or commercial entity or person, for any improper purpose, including the purpose of influencing such person to purchase Products or otherwise benefit the business of Seller. Buyer further represents and agrees that it will not receive, use, service, transfer or ship any Product from Seller in a manner or for a purpose that violates Export Laws or would cause Seller to be in violation of Export Laws.

05/17



Parker's Motion & Control Technologies

At Parker, we're guided by a relentless drive to help our customers become more productive and achieve higher levels of profitability by engineering the best systems for their requirements. It means looking at customer applications from many angles to find new ways to create value. Whatever the motion and control technology need, Parker has the experience, breadth of product and global reach to consistently deliver. No company knows more about motion and control technology than Parker. For further info call 1 800 C-Parker (1 800 272 7537)



Aerospace

Key Markets

Aftermarket services
Commercial transports
Engines
General & business aviation
Helicopters
Launch vehicles
Military aircraft
Missiles
Power generation
Regional transports
Unmanned aerial vehicles

Key Products

Control systems & actuation products
Engine systems & components
Fluid conveyance systems & components
Fluid metering, delivery & atomization devices
Fuel systems & components
Fuel tank inerting systems
Hydraulic systems & components
Thermal management
Wheels & brakes



Climate Control

Key Markets

Agriculture
Air conditioning
Construction Machinery
Food & beverage
Industrial machinery
Life sciences
Oil & gas
Precision cooling
Process
Refrigeration
Transportation

Key Products

Accumulators
Advanced actuators
CO₂ controls
Electronic controllers
Filter driers
Hand shut-off valves
Heat exchangers
Hose & fittings
Pressure regulating valves
Refrigerant distributors
Safety relief valves
Smart pumps
Solenoid valves
Thermostatic expansion valves



Electromechanical

Key Markets

Aerospace
Factory automation
Life science & medical
Machine tools
Packaging machinery
Paper machinery
Plastics machinery & converting
Primary metals
Semiconductor & electronics
Textile
Wire & cable

Key Products

AC/DC drives & systems
Electric actuators, gantry robots & slides
Electrohydraulic actuation systems
Electromechanical actuation systems
Human machine interface
Linear motors
Stepper motors, servo motors, drives & controls
Structural extrusions



Filtration

Key Markets

Aerospace
Food & beverage
Industrial plant & equipment
Life sciences
Marine
Mobile equipment
Oil & gas
Power generation & renewable energy
Process
Transportation
Water Purification

Key Products

Analytical gas generators
Compressed air filters & dryers
Engine air, coolant, fuel & oil filtration systems
Fluid condition monitoring systems
Hydraulic & lubrication filters
Hydrogen, nitrogen & zero air generators
Instrumentation filters
Membrane & fiber filters
Microfiltration
Sterile air filtration
Water desalination & purification filters & systems



Fluid & Gas Handling

Key Markets

Aerial lift
Agriculture
Bulk chemical handling
Construction machinery
Food & beverage
Fuel & gas delivery
Industrial machinery
Life sciences
Marine
Mining
Mobile
Oil & gas
Renewable energy
Transportation

Key Products

Check valves
Connectors for low pressure fluid conveyance
Deep sea umbilicals
Diagnostic equipment
Hose couplings
Industrial hose
Mooring systems & power cables
PTFE hose & tubing
Quick couplings
Rubber & thermoplastic hose
Tube fittings & adapters
Tubing & plastic fittings



Hydraulics

Key Markets

Aerial lift
Agriculture
Alternative energy
Construction machinery
Forestry
Industrial machinery
Machine tools
Marine
Material handling
Mining
Oil & gas
Power generation
Refuse vehicles
Renewable energy
Truck hydraulics
Turf equipment

Key Products

Accumulators
Cartridge valves
Electrohydraulic actuators
Human machine interfaces
Hybrid drives
Hydraulic cylinders
Hydraulic motors & pumps
Hydraulic systems
Hydraulic valves & controls
Hydrostatic steering
Integrated hydraulic circuits
Power take-offs
Power units
Rotary actuators
Sensors



Pneumatics

Key Markets

Aerospace
Conveyor & material handling
Factory automation
Life science & medical
Machine tools
Packaging machinery
Transportation & automotive

Key Products

Air preparation
Brass fittings & valves
Manifolds
Pneumatic accessories
Pneumatic actuators & grippers
Pneumatic valves & controls
Quick disconnects
Rotary actuators
Rubber & thermoplastic hose & couplings
Structural extrusions
Thermoplastic tubing & fittings
Vacuum generators, cups & sensors



Process Control

Key Markets

Alternative fuels
Biopharmaceuticals
Chemical & refining
Food & beverage
Marine & shipbuilding
Medical & dental
Microelectronics
Nuclear Power
Offshore oil exploration
Oil & gas
Pharmaceuticals
Power generation
Pulp & paper
Steel
Water/wastewater

Key Products

Analytical Instruments
Analytical sample conditioning products & systems
Chemical injection fittings & valves
Fluoropolymer chemical delivery fittings, valves & pumps
High purity gas delivery fittings, valves, regulators & digital flow controllers
Industrial mass flow meters/controllers
Permanent no-weld tube fittings
Precision industrial regulators & flow controllers
Process control double block & bleeds
Process control fittings, valves, regulators & manifold valves



Sealing & Shielding

Key Markets

Aerospace
Chemical processing
Consumer
Fluid power
General industrial
Information technology
Life sciences
Microelectronics
Military
Oil & gas
Power generation
Renewable energy
Telecommunications
Transportation

Key Products

Dynamic seals
Elastomeric o-rings
Electro-medical instrument design & assembly
EMI shielding
Extruded & precision-cut, fabricated elastomeric seals
High temperature metal seals
Homogeneous & inserted elastomeric shapes
Medical device fabrication & assembly
Metal & plastic retained composite seals
Shielded optical windows
Silicone tubing & extrusions
Thermal management
Vibration dampening

ENGINEERING YOUR SUCCESS.

Parker Fluid Connectors Group

North American Divisions & Distribution Service Centers

Your complete source for quality tube fittings, hose & hose fittings, brass & composite fittings, quick-disconnect couplings, valves and assembly tools, locally available from a worldwide network of authorized distributors.

Fittings:

Available in inch and metric sizes covering SAE, BSP, DIN, GAZ, JIS and ISO thread configurations, manufactured from steel, stainless steel, brass, aluminum, nylon and thermoplastic.

Hose, Tubing and Bundles:

Available in a wide variety of sizes and materials including rubber, wire-reinforced, thermoplastic, hybrid and custom compounds.

Worldwide Availability:

Parker operates Fluid Connectors manufacturing locations and sales offices throughout North America, South America, Europe and Asia-Pacific.

For information, call toll free...

1-800-C-PARKER
(1-800-272-7537)

North American Divisions

Fluid System Connectors Division

Otsego, MI
phone 269 694 9411
fax 269 694 4614

Hose Products Division

Wickliffe, OH
phone 440 943 5700
fax 440 943 3129

Industrial Hose Division

Wickliffe, OH
phone 440 833 2120
fax 440 833 2230

Parflex Division

Ravenna, OH
phone 330 296 2871
fax 330 296 8433

Quick Coupling Division

Minneapolis, MN
phone 763 544 7781
fax 763 544 3418

Tube Fittings Division

Columbus, OH
phone 614 279 7070
fax 614 279 7685

Distribution Service Centers

Buena Park, CA

phone 714 522 8840
fax 714 994 1183

Conyers, GA

phone 770 929 0330
fax 770 929 0230

Louisville, KY

phone 502 937 1322
fax 502 937 4180

Portland, OR

phone 503 283 1020
fax 503 283 2201

Toledo, OH

phone 419 878 7000
fax 419 878 7001
fax 419 878 7420
(FCG Kit Operations)

Canada

Milton, ONT

phone 905-693-3000
fax 905-876-1958
(Contact Milton for other Service Center locations.)



Parker Hannifin Corporation
Parflex Division
1300 North Freedom Street
Ravenna, Ohio 44266
Phone 330.296.2871
Fax 330.296.8433
www.parker.com/pfd

Authorized Distributor

800-525-9085
www.mfcinc.com

MFCP MOTION & FLOW
CONTROL PRODUCTS, INC.